

May 2014

# Examining a Novel Set of Executive Function Measures Using Event Related Potentials

Danielle Cara Blinkoff

University of South Florida, [dblinkoff@mail.usf.edu](mailto:dblinkoff@mail.usf.edu)

Follow this and additional works at: <http://scholarcommons.usf.edu/etd>

 Part of the [Psychology Commons](#)

---

## Scholar Commons Citation

Blinkoff, Danielle Cara, "Examining a Novel Set of Executive Function Measures Using Event Related Potentials" (2014). *Graduate Theses and Dissertations*.

<http://scholarcommons.usf.edu/etd/4985>

This Thesis is brought to you for free and open access by the Graduate School at Scholar Commons. It has been accepted for inclusion in Graduate Theses and Dissertations by an authorized administrator of Scholar Commons. For more information, please contact [scholarcommons@usf.edu](mailto:scholarcommons@usf.edu).

Examining a Novel Set of Executive Function Measures Using Event Related Potentials

by

Danielle C. Blinkoff

A thesis submitted in partial fulfillment  
of the requirements for the degree of  
Master of Arts  
with a concentration in Clinical Psychology  
Department of Psychology  
College of Arts and Science  
University of South Florida

Major Professor: Cynthia Cimino, Ph.D.  
Geoffrey Potts, Ph.D.  
Marina Bornovalova, Ph.D.

Date of Approval:  
February 26, 2014

Keywords: neuropsychology, electrophysiology, inhibition, set-shifting, updating

Copyright © 2014, Danielle C. Blinkoff

## Table of Contents

List of Tables	iii
List of Figures	iv
Abstract	vi
Chapter One: Introduction	1
Neuroanatomy Associated with Executive Function	1
Three Executive Components: Inhibition, Set-Shifting and Updating	2
Inhibition (to Prepotent Response)	4
Anatomy and inhibition	5
ERP literature and inhibition	6
Mental Set-Shifting	8
Anterior cingulate cortex activation and set-shifting	10
Set-shifting and inhibition	10
Set-shifting and the P3a	11
Set-shifting and the P3b	12
Updating (and Monitoring of Working Memory Representation)	14
Anatomy and updating	15
Inhibition and working memory	16
ERP literature and updating (P3b)	17
Problems with Current Clinical Executive Function Tasks	18
Rationale of the Study	21
Purpose of the Current Study	23
Hypotheses	23
Chapter Two: Methods	26
Participants	26
Experimenters	26
Measures	27
Neuropsychological Measures (Clinical EF Measures)	27
Wisconsin Card Sorting Task	27
Letter-Number Sequencing	28
Stroop Test	28
Trail Making A & B	28
The Novel Executive Function Tasks	29
Apparatus	29
Procedure	30
ERP Extraction Procedure	31

Chapter Three: Results	32
Behavioral Data (Novel Tasks Reaction Time) Diagnostics	32
Examination of Outliers: Individual Participants By Condition	33
Examination of Normality and Outliers: Participants By Overall Mean of Condition	33
Multivariate Normality and Outliers for RT Data	35
Multivariate Analysis for RT data	36
N-Back Accuracy Analysis	39
Neuropsychological Task Diagnostics (Clinical EF Measures)	40
EEG Data Diagnostics	42
RT Data for Participants Included in ERP Analysis	43
ERP Analysis Procedures	43
Hypothesis 1 Data Analysis	44
Inhibition Hypothesis	44
Inhibit task results	44
Go/No-Go task results	46
Set-Shift Hypothesis	48
Set-shift results	48
Updating (N-Back) Hypothesis	51
Updating (N-Back) results	51
Hypothesis 2 Data Analysis	53
Control Task Results	53
Inhibition Task Results	53
Set-Shifting Task Results	54
N-Back Task (Updating) Results	56
Chapter Four: Discussion	60
Control Task	60
Inhibition	61
Set-Shifting	64
Updating	66
Reaction Time Data	68
Limitations	68
Conclusions and Future Directions	69
References	72
Appendix A: Test Development and Piloting	86
Appendix B: Piloting Questionnaire	91
Appendix C: Novel Task Descriptions	92
Appendix D: Institutional Review Board Approval Letters	100

## List of Tables

Table 1:	Percent Accuracy For All Novel Tasks	32
Table 2:	Descriptive Statistics of Novel Measures (Including Outliers)	34
Table 3:	Data Points Identified as Outliers at $p < .05$ for the Novel Tasks (RT)	34
Table 4:	Descriptive Statistics of RT of Novel Measures (with RT Outliers Removed)	35
Table 5:	Descriptive Statistics of the Clinical EF Measures (Outliers Included)	41
Table 6:	Data Points Identified as Outliers at $p < .05$	41
Table 7:	Descriptive Statistics of the Neuropsychological Measures (Outliers Removed)	41
Table 8:	Participants Included in ERP analysis	42
Table 9:	Relationships Between RT on Novel Tasks and Performance on Clinical EF Measures (Outliers Not Removed)	58
Table 10:	Relationships Between RT on Novel Tasks and Performance on Clinical EF Measures with Outliers Removed	59
Table 11:	Mean Reaction Time and Pooled Accuracy for All Subjects	87
Table 12:	Accuracy and Mean Reaction Time (ms) for Each Participant	88

## List of Figures

Figure 1:	Mean RT for Inhibit Vs. Control Conditions	37
Figure 2:	Mean RT for Go Vs. Control Conditions	37
Figure 3:	Mean RT for Shift vs. Stay Conditions	38
Figure 4:	Mean RT For Memory Load	38
Figure 5:	Mean RT for Congruent vs. Incongruent Conditions	39
Figure 6:	N-Back Mean Accuracy (Out of 40 Trials) and Percentage of Correct Trials	40
Figure 7:	Frontocentral Waveform for the Inhibit Task with Vertical Lines Indicating the 300-530ms Epoch	45
Figure 8:	Posterior-Central Waveform for the Inhibit Task with Vertical Lines Indicating the 260-560ms Epoch	46
Figure 9:	Frontocentral Waveform for the Go/No-Go Task with Vertical Lines Indicating the 130-280ms and 310-520ms Epochs	47
Figure 10:	Posterior Waveform for the Go/No-Go Task with Vertical Lines Indicating the 240-540ms Epoch	47
Figure 11:	Frontocentral Waveform for the Set-Shift task with Vertical Lines Indicating the 115-140ms and 310-480ms Epochs	48
Figure 12:	Parietal-Central Waveform for the Set-shift Task with Vertical Lines Indicating the 115-140ms and 272-456ms Epochs	49
Figure 13:	Frontal Waveform for the Set-shift Task Examining Congruent and Incongruent Trials with Vertical Lines Indicating the 176-288ms, 300-424ms, and 496-560ms Epochs	50
Figure 14:	Posterior Waveform for the Set-Shift Task Examining Congruent and Incongruent Trials with Vertical Lines Indicating the 116-144ms and 400-484ms Epochs	50

Figure 15:	Posterior Waveform for the N-back Task Indicating P3b Epoch (248-472ms)	52
Figure 16:	Frontal Waveform for the N-back Task Indicating 168-208ms and 252-468ms Epochs	52
Figure 17:	Relationship between Inhibit Performance (RT) and Stroop Color-Word Raw Scores	54
Figure 18:	Relationship between the Shift Condition of the Set-Shifting Task and TMT-B Time to Complete	55
Figure 19:	Relationship Between Total Letter Number Sequencing Score and 1-Back Reaction Time	57
Figure 20:	Control Task	92
Figure 21:	Inhibit Task	93
Figure 22:	Go/No-Go Task	94
Figure 23:	Set-Shift Task	95
Figure 24:	N-Back Task	96

## Abstract

The nature and assessment of executive function are areas of active research. Many current assessments of executive function are complex, have limited reliability and validity, and suffer from task impurity, meaning other cognitive processes may indirectly influence task performance. Additionally, measures may be culture, language, or education bound limiting their use in certain populations (Miyake, Emerson, & Friedman, 2000; Miyake, Friedman, et al., 2000; Strauss, Sherman, & Spreen, 2006; Stuss, 2007). The purpose of this project was to develop a novel set of executive function measures to address issues with current clinical measures. The new measures 1) can be used in an ERP environment, 2) use the same stimulus set to address task impurity and 3) use simpler cognitive operations of inhibition, set-shifting, and updating, identified in previous research by Miyake et al., (2000). Twenty-nine undergraduate participants at the University of South Florida were administered currently used clinical measures of executive function theorized to engage in inhibition, set-shifting, and updating and the set of the novel tasks. ERP data was collected during the administration of the novel tasks. Behaviorally, conditions theorized to engage executive function resulted in slower response reaction time than control conditions. Additionally, behavioral results indicated that performance on novel tasks were differentially related to different clinical EF tasks. ERP differences were observed between both Go/No-Go conditions (inhibition) and among N-back conditions (updating). Results suggest the novel executive function tasks are tapping into different cognitive processes and may be a viable tool for studying executive function in the future.



## **Chapter One:**

### **Introduction**

“Executive functions” is an umbrella term used to describe higher order functioning. Though there is no standard definition of executive function, most individuals in the field generally agree that executive function involves mental operations needed in novel or in non-routine situations, in which there is not an established stimulus-response association. Executive function involves goal directed behavior and top-down control (Gilbert & Burgess, 2008) and is necessary when the more dominate response would produce the incorrect behavior (Miller & Cohen, 2001). Different researchers have different ideas about what mental operations encompass executive function. According to Banich, executive functions involve inhibiting familiar behavior, creating attentional or mental sets of relevant information for a current goal, task switching, and rule learning (2009). Others have defined executive function as involving inhibition, planning, working memory, evaluating consequences, learning and using rules (Miller & Wallis, 2009). Still, others suggest that executive function encompasses reasoning, organization, planning and problem solving (Suchy, 2009).

#### **Neuroanatomy Associated with Executive Function**

Executive function and abstract thinking have been associated with the prefrontal cortex. Prefrontal damage is associated with impaired decisions at the level of abstraction (Badre, Hoffman, Cooney, & D'Esposito, 2009). The prefrontal cortex is important for the internal representation and achievement of goals. When there are multiple alternatives for a behavior,

environmental cues activate internal representations within the prefrontal cortex (PFC) and initiate a course of action (Miller & Cohen, 2001).

Executive function is not solely associated with the prefrontal cortex; the frontal lobes are a site of information integration (Stuss, 2011). Executive function can be traced to other brain regions, such as the basal ganglia, that have a significant degree of connectivity and communication with the prefrontal region due to frontal-subcortical circuits (Leh, Petrides, & Strafella, 2009; Mega & Cummings, 1994). When disruptions occur along these circuits, neuropsychiatric syndromes may manifest, with symptoms of executive dysfunction, disinhibition and apathy (Masterman & Cummings, 1997; Mega & Cummings, 1994). Because executive functions are associated with many different brain regions, some authors discourage labeling executive function tasks with anatomical references (Strauss et al., 2006).

### **Three Executive Components: Inhibition, Set-Shifting and Updating**

Teuber (1972) defined executive function as having both unity and diversity. Unity means that there is a common element that is the same for all executive components and diversity indicates that there is some uniqueness for each specific executive component (Miyake, Friedman, et al., 2000). Performance on executive function tasks are typically correlated with each other, suggesting an underlying ability common to all executive functions, but are also diverse because they are not correlated completely (Friedman et al., 2008; Miyake & Friedman, 2012). Miyake and colleagues (2000) identified three lower level executive components of inhibition, mental set-shifting, and updating as a basis for executive function theory. Higher-level executive functions, such as planning, were not identified. Miyake et al., (2000) have provided some evidence that inhibition, set-shifting, and updating are separable by using factor analytic and structural equation modeling approaches with currently used neuropsychological

measures. Several studies following Miyake and colleagues' paper support the idea that inhibition, set-shifting and updating are distinct. Genetics influence each of the three separately, for example. In a monozygotic and dizygotic twin study, participants were given executive function tasks representing inhibition, set-shifting, and updating. The researchers found almost no environmental influence on executive function (except for set-shifting ability), suggesting that executive function is almost entirely inheritable. They also concluded that overall executive function ability and ability in each unique executive component appears to be heavily influenced by genetics (Friedman et al., 2008). Updating has been shown to have a strong relationship with intelligence, while inhibition and set-shifting do not (Friedman et al., 2006). Different prefrontal areas have been shown to be activated during inhibition tasks and switching of attention (Sylvester et al., 2003). Additional evidence from studies using factor analytic techniques supports separable components of executive function. A study examining executive functioning in older adults found a similar factor structure to Miyake et al. (2000) with the addition of a factor related to long term memory (Fisk & Sharp, 2004). In a study of executive function and scholastic achievement in 11 and 12 year old children, inhibition, set-shifting, and updating were measured. Tasks based on Miyake, Friedman, et al. (2000) were used for the study, but only separate factors for inhibition and updating were found. Perhaps shifting tasks involve some aspects of inhibition or updating, or the results may reflect a difference between children and adults developmentally (St Clair-Thompson & Gathercole, 2006). A study that examined 19 neuropsychological tests of executive function with exploratory factor analysis found six independent factors associated with executive function: prospective working memory, set-shifting and interference management, task analysis, response inhibition, strategy generation and regulation, and self-monitoring and set-maintenance. Measures were weakly correlated,

suggesting that executive functions are discrete, which supports the idea that executive function is diverse in nature (Testa, Bennett, & Ponsford, 2012).

### **Inhibition (to Prepotent Response)**

Inhibition is the ability to purposefully hinder a dominant, automatic, or prepotent response (Miyake, Friedman, et al., 2000). Inhibition is an important executive component needed for adaptation to the environment (Chikazoe et al., 2009). Inhibition can be applied to physical responses (motor or behavioral inhibition), a distracter (selective attention), emotion, and memory. Active inhibition involves the suppression of a stimulus, memory or response (Aron, 2007). Response inhibition, a specific type of active inhibition, is an intentional process that involves stopping behavior that interferes with achieving a goal and selecting an alternate behavior (Mostofsky & Simmonds, 2008). There is some evidence that response inhibition can occur outside of consciousness (van Gaal, Ridderinkhof, van den Wildenberg, & Lamme, 2009) and can be influenced by automatic processing (Verbruggen & Logan, 2009). Unconscious inhibitory control has also been supported through ERP research, where Nogo N2 and P3 amplitudes were larger following an incongruent prime and were reduced following a congruent prime (Hughes, Velmans, & De Fockert, 2009). Cognitive control, or top-down processing, is particularly relevant to motor aspects of response inhibition, as there needs to be an active mechanism that stops an already initiated response (Aron, 2007). There is also evidence to suggest that context monitoring, not motoric stopping, is responsible for response inhibition (Chatham et al., 2012).

Perhaps inhibition is a more basic executive function than updating and set-shifting. Recent work by Miyake and colleagues suggests that there may not be an inhibition specific executive component. Recent factor analytic studies suggest the inhibition factor correlates

completely with a common executive function factor, with all inhibition's variance accounted for in the common executive function factor. This is not the case for set-shifting and updating, indicating that are updating-specific and set-shifting specific abilities (Friedman et al., 2008; Miyake & Friedman, 2012). This is also supported by studies that have shown low within construct correlations for inhibition tasks (Friedman & Miyake, 2004; Friedman et al., 2008). Inhibition may be related to active maintenance and management of current task goals whereas updating and set-shifting involve resistance to prepotent responses plus additional abilities (Friedman et al., 2008). Miyake et al. (2000) suggests updating may require the suppression of irrelevant information and set-shifting may require the deactivation of a previous set of rules or information, which makes these components more unique than inhibition.

Typical tasks that are used to evaluate inhibition are the Stroop task (Golden, 1978), Go/No-Go tasks, the antisaccade task and the stop-signal task (Aron, 2007; Miyake, Friedman, et al., 2000). All of these tasks involve the stopping of a prepotent or automatic response. For example, the Stroop involves an interference subtest where color words are written in different color ink than the word describes. Reading is a more automatic process than color naming, so examinees must inhibit reading to provide the correct response.

**Anatomy and inhibition.** Damage to the prefrontal cortex may result in stimulus-bound behaviors (Miller & Wallis, 2009). The right inferior frontal cortex (IFC) is associated with inhibition of initiated motor response, control of task sets, and attentional interference (Menon, Adleman, White, Glover, & Reiss, 2001; Mostofsky & Simmonds, 2008). Response inhibition is also associated with medial frontal premotor circuits, which are involved with motor response preparation. The anterior cingulate cortex's role in inhibition is error monitoring. The rostral portion of the supplementary motor area (pre-SMA) is associated with response preparation,

selection, and execution. Early activation of the pre-SMA is associated with successful response selection (Mostofsky & Simmonds, 2008). Studies have shown that individuals with lesions to the pre-SMA have deficits in performance in response inhibition tasks (Floden & Stuss, 2006; Mostofsky & Simmonds, 2008; Picton et al., 2007). Additionally, when comparing go/no-go task performance between individuals with left inferior frontal gyrus (IFG) lesions, individuals with orbital frontal cortex lesions, and normal controls, participants with IFG damage made more errors on the task than the other two groups, suggesting the IFG is associated with inhibitory control (Swick, Ashley, & Turken, 2008).

**ERP literature and inhibition.** The Nogo-N2 and Nogo-P3 are ERP components associated with inhibition. The Nogo-N2 and P3 make up a frontocentral negative-positive complex that is elicited by No-Go stimuli (Falkenstein, Hoormann, & Hohnsbein, 2002). The N2 wave peaks around 200-400ms and the P3 wave peaks around 300-500ms after stimulus onset (Bekker, Kenemans, & Verbaten, 2005; Falkenstein, Hoormann, & Hohnsbein, 1999; Falkenstein et al., 2002). There is evidence to suggest that these components depend on the processes of prefrontal regions, specifically the ACC and are related to the dopamine system (Beste, Saft, Gold, & Falkenstein, 2008).

The frontocentral N2 component is associated with cognitive control, response inhibition, response conflict, and error monitoring (Folstein & Van Petten, 2008). The N2 is elicited when a prepared motor response requires inhibition and amplitude is larger during successful inhibition trials (Eimer, 1993; Gruendler, Ullsperger, & Huster, 2011; Jodo & Kayama, 1992). N2 amplitude and latency is affected by probability, with rare no-go stimuli eliciting a larger N2 amplitude than common no-go stimuli and a longer latency than the Go-N2, but only when probabilities of the Go and Nogo trials are different. Thus, the classic interpretation of the N2 is

that it reflects frontal inhibition (Jodo & Kayama, 1992). One of the issues with this hypothesis, however, is that the N2 is only elicited during inhibition tasks using visual stimuli. Therefore, the N2 maybe modality specific (Falkenstein et al., 2002).

There is debate whether the N2 component reflects inhibition. Some theorize that the N2 actually reflects conflict monitoring. Inhibition inherently requires conflict monitoring, as tasks that require the inhibition of a prepotent response involve conflict between the automatic response and the correct response (Botvinick, Cohen, & Carter, 2004). One study tried to determine whether the N2 reflects response inhibition or conflict monitoring through the use of a go/no-go task. According to the inhibition hypothesis, the N2 should be more prominent in response to no-go stimuli than go stimuli. The conflict-monitoring hypothesis would be supported if similar amplitudes are elicited for both the go and no-go stimuli. The results supported the latter hypothesis. The authors explain the reason why others may have obtained results that support the inhibition hypothesis is because more conflict monitoring is required in conditions with low probabilities (Donkers & Van Boxtel, 2004). Several additional theories have been postulated about the cognitive processes associated with the elicitation of the N2. The N2 may reflect initiation of inhibition (van Gaal, Lamme, Fahrenfort, & Ridderinkhof, 2011) or the non-motor stage or recognition for the need to initiate inhibition (Smith, Johnstone, & Barry, 2008). Another theory is that N2 may be related to selective attention and not overall executive function. In a study where healthy individuals performed the Flanker task along with other paper and pencil neuropsychological tests, the N2 produced was not correlated with the neuropsychological tests of executive function (Larson & Clayson, 2011).

The Nogo P3 is elicited over frontocentral electrodes (Hughes et al., 2009) and most likely represents general inhibition and is a different subprocess than the Nogo N2. A study of

inhibition in a geriatric population found both P3 and N2 latency were delayed during trials of inhibition, but the N2 was delayed to a lesser extent and only after visual stimuli. Because there were greater effects for the P3, the results suggested that the N2 and P3 reflect different processes of inhibition (Falkenstein et al., 2002). In an experiment examining inhibition in Parkinson's disease (PD), the Nogo P3 was associated with set-shifting and working memory performance, but Nogo-N2 was not (Bokura, Yamaguchi, & Kobayashi, 2005). Another study in Huntington's disease (HD) patients using a go/no-go task found reduced Nogo P3 amplitude with preserved Nogo N2. The results suggest that the Nogo N2 might reflect pre-motor inhibition and conflict monitoring, while the Nogo P3 may be more related to the evaluation of inhibitory processes (Beste et al., 2008) with the P3 being involved with the post response phase of response inhibition for error detection and preparing for future trials (Roche, Garavan, Foxe, & O'Mara, 2005). Other research suggests that the Nogo P3 represent both cognitive and motor inhibition (Enriquez-Geppert, Konrad, Pantev, & Huster, 2010; Smith et al., 2008).

Response inhibition is the ability to overcome prepotent responses. This executive component may be common to most tasks of executive function as recent factor analytic studies suggest that there are no inhibition specific abilities that are separate from the common executive function. The inferior frontal cortex and the Nogo N2 and P3 ERP components are consistently associated with inhibition.

### **Mental Set-Shifting**

Set-shifting is an executive process that involves disengaging a set of rules for an irrelevant task and activating rules for an alternate task (Miyake, Friedman, et al., 2000). In a typical task-switching experiment, participants are given rules for two simple tasks to perform and are required to switch between the two rules based on either exogenous or endogenous cues.



Switching between a set of tasks can incur lower accuracies and slowed reaction times, referred collectively as switch cost effects (Jersild, 1927; Kieffaber & Hetrick, 2005; Monsell, 2003). Jersild (1927) was one of the first to study mental set-shifting with the use of the plus-minus task. In the study, participants were given a list of math problems without an operational sign and had to switch between adding and subtracting in each trial. Another example of a set-shifting task is the Trails B portion of the Trail Making task. Part A is a timed search task that requires the tested individual to connect numbered circles in order as quickly as possible. Trails B introduces switch into the task, as individual must connect numbered and lettered circles in order, alternating between number and letter (Lezak, 2012).

There are four basic characteristics that are present in set-shifting tasks. Response time is longer on a switch trial than a repetition trial. When participants are given a cue for switch and enough time to prepare, switch cost is typically reduced, though switch cost is usually not eliminated. There are also long-term and transient set-shifting costs, even though performance typically recovers after a switch (Monsell, 2003). Additionally, a larger shift cost occurs for tasks where the cue is endogenous, meaning individuals need to remember to shift without a cue, than when there an exogenous cue or stimulus is presented (Spector & Biederman, 1976). There is also a larger switch cost when switch and repeat trials are blocked rather than intermixed (Braver, Reynolds, & Donaldson, 2003; Lenartowicz, Escobedo-Quiroz, & Cohen, 2010; Rubin & Meiran, 2005).

There are two prominent explanations for switch cost effects in set-shifting tasks: the interference and reconfiguration theories. According to the interference theory, switch cost reflects time to resolve interference. Task switch cost occurs because of the requirement to overcome activation of a previous task. This is due to a carryover effect of a competing stimulus-

response (Kieffaber & Hetrick, 2005; Vandierendonck, Liefoghe, & Verbruggen, 2010). The reconfiguration theory infers that switch cost reflects the time needed to reconfigure a task set and switching requires the reconfiguration of mental resources (Monsell, 2003; Vandierendonck et al., 2010). This may be due to a failure in anticipatory process that controls the configuration of the mental set in advance of the new target stimuli. Support for reconfiguration comes from studies that have found a correlation with reduction in switch costs and longer preparatory intervals between switch trials. This theory is challenged, however, by the fact that residual switch cost is rarely eliminated, regardless of the amount of preparatory time given (Arbuthnott & Frank, 2000; Kieffaber & Hetrick, 2005; Monsell, 2003).

**Anterior cingulate cortex activation and set-shifting.** The anterior cingulate cortex (ACC) is a brain region that has been associated with set-shifting. A MEG study showed activity in response to shifting cues in the inferior frontal gyrus (IFG), the frontomedial wall of the anterior cingulate cortex, and the supramarginal gyrus (SMG). Temporal course of activation was IFG and ACC and then the SMG and ACC (Periáñez et al., 2004). The ACC is known to be involved with conflict monitoring and executive attention (Botvinick, Braver, Barch, Carter, & Cohen, 2001). The ACC plays a conflict monitoring role during incongruent or switch trials. Dorsal and caudal regions of the ACC detect pre-response and response-level conflict. In a study using the global-local set-shifting task, pre-response conflict activated the dorsal ACC (Weissman, Giesbrecht, Song, Mangun, & Woldorff, 2003). The dorsal ACC appears to be involved in focusing attention to task-relevant stimuli, which helps resolve conflict from distractions (Weissman, Gopalakrishnan, Hazlett, & Woldorff, 2005).

**Set-shifting and inhibition.** There is some evidence that there is some overlap with set-shifting and inhibition. Arbuthnott and Frank (2000) suggested that inhibition is required to

disengage from a previous task set and may affect residual switch costs. Switch trials involve the inhibition of the current task set and response, and the inhibition of the memory of the task set (Aron, 2007). This raises the question of whether switching could occur without inhibition. Task inhibition occurs when there is conflict during response selection (Koch, Gade, Schuch, & Philipp, 2010). An fMRI study using the global-local task attempted to determine areas of activation that are both common and discrepant for inhibition and set-shifting. The two conditions were to either shift response to global or local levels or respond to only one level. Inhibition was induced by having incongruence between the global and local letters, while shift was induced by having the participant switch from local to global levels. There were activations related to both inhibition and set-shifting in bilateral prefrontal (which include the dorsolateral prefrontal cortex, ventral lateral prefrontal cortex, and ACC), parietal, and basal ganglia areas. Inhibition was associated with the dorsolateral and ventrolateral prefrontal cortex, the parietal lobes, and the temporal-parietal junction. No unique regions were activated shifting alone (Hedden & Gabrieli, 2010). Additionally, inferior frontal cortex (IFC) damage can predict switch costs. People with IFC damage incur greater switch costs. This suggests the IFC controls inhibition and additionally controlling resistance to interference during switching (Aron, 2007; Aron, Monsell, Sahakian, & Robbins, 2004).

**Set-shifting and the P3a.** The P3a component is typically associated with the brain's response to novelty (Friedman, Cycowicz, & Gaeta, 2001). It is a frontocentral positive wave peaking between 250-500ms (Polich, 2007). Several studies have supported an association between the frontally distributed P3a and attentional set-shifting (Barceló, 2003; Barceló, Periáñez, & Knight, 2002). In a study using the Wisconsin Card Sorting Task (WSCT), events that caused a shift in set to new rules elicited the P3a (Barceló et al., 2002). Another study used a

similar card sorting task (Madrid Card Sorting Test) and measured ERPs that were time-locked to shifts in set. Results suggested that the P3a is a reflection of a brain switching mechanism that is sensitive to task and stimulus novelty. Additionally, there was residual P3a activity after the first feedback stay cue, where participants were alerted to not switch sets. P3a activity was eliminated after a second stay cue. This may reflect the brain continuing to reorient to the new task after the first stay cue (Barceló, 2003). Though evidence does support the theory that the P3a is reflecting set-shift, there is also evidence to suggest that the P3a may reflect reallocation of attention (Friedman, Nessler, Johnson Jr, Ritter, & Bersick, 2007).

**Set-shifting and the P3b.** Several studies have also demonstrated a relationship between set-shifting and the posterior P3b component. The P3b is a partial-central positive waveform peaking between 250-500ms (Polich, 2007). When performing the WCST, a large posterior P3b wave is elicited 300ms after choice card onset. The choice card was the card that needed to be classified and placed in one of four piles. Though the authors believed this may represent working memory demands needed for the task (Barceló, Sanz, Molina, & Rubia, 1997), more recent studies have shown that P3b activity is unaffected by number of task-sets in working memory nor the predictability of task sets (Barceló, 2003; Barceló, Muñoz-Céspedes, Pozo, & Rubia, 2000; Barceló et al., 2002). One of these more recent studies also used the WCST. Attenuation of the P3b was found during shift trials, followed by a P3b build up, meaning an increase in amplitude, during post-shift trials. P3b activity was not observed when the new rule was cued exogenously. Results suggest that the P3b may be influenced by an endogenous shift in rules for the task. They also found that the P3b reached its highest amplitude a few trials after learning the new rule. This may be due to a reconfiguration of working memory and updating of the attentional set. During shift trials, a slight asymmetry was noted, with reduction of the P3b

over left temporal and temporal-occipital regions. A post-shift P3b build-up (i.e. increase over time) was also observed, extending over several non-shift trials, which may be the result of reconfiguration of the attentional set (Barceló et al., 2000; Kieffaber & Hetrick, 2005). This P3b activation is correlated with improvement in response speed and efficiency (Barceló, 2003).

In a study observing ERPs in both younger and older adults, younger adults, switch trials elicit a fronto-central P3 component. In older adults, there is no difference in P3b amplitude between switch and non-switch trial types. This may be because older adults update task sets on all trial types (Friedman et al., 2007). This is also supported by another study which found P3 amplitude is weaker in older adults in task-switching trials (West & Moore, 2005). Another study found that cues associated with switch was related to the P3b. P3b is also found to be larger in non-shift trials than control trials. This may be because the P3b reflects additional neural resources that are needed to complete the task. Like several other studies, task switching was associated with significant response costs. They also found that changes in P2 and P3a amplitude was dependent on whether participants were switching from an easy task to a harder task and vice versa. When switching to a less complicated task, smaller P2 and P3a amplitudes were observed. Two P3b-like components were elicited; one was associated with a switch cue and the other associated with target presentation. The latter component is elicited anterior to the cue-associated component. These two different P3b components may reflect two types of processing: anticipatory and stimulus dependent. These results complement both the reconfiguration/ anticipatory and interference models of set-shifting (Kieffaber & Hetrick, 2005) and is supported by another study that found P3 activity during preparation for set shift (Lavric, Mizon, & Monsell, 2008).

Set-shifting involves the ability to switch from one task set to another. Brain regions typically associated with set-shifting include the ACC, an area of the brain known to be involved in conflict monitoring, and the IFC, though this may be because of the inhibition aspect of set-shifting tasks. The P3a and P3b ERP components are elicited during set-shifting tasks.

### **Updating (and Monitoring of Working Memory Representations)**

Working memory is a limited capacity store that retains information that can be manipulated (Strauss et al., 2006). Miyake and colleagues used the term “updating” to describe an executive component that involves the monitoring and coding of information and revising items held in short term memory by replacing old irrelevant information with relevant information (Miyake, Friedman, et al., 2000), as well as the deletion and addition of working memory contents (Miyake & Friedman, 2012).

One of the most prominent theories of working memory is Baddley and Hitch’s model (1974). They originally proposed a three-component system consisting of the central executive and two storage systems: the visuospatial sketchpad and the phonological loop. The phonological loop maintains information by vocal and subvocal rehearsal, while the visuospatial sketchpad stores non-verbal information (Baddeley, 2012). The central executive was originally thought to involve attentional focus, storage, and decision-making and is responsible for retrieving information into conscious awareness and manipulating or modifying the information (Baddeley, 2000). The executive control mechanism of working memory focuses attention to goal-relevant information while interfering information is present (Conway, Kane, & Engle, 2003; Lezak, 2012).

The N-back is a classic working memory paradigm that requires participants to update contents held in working memory as the task progresses. The task involves remembering the

identity of a stimulus and its ordinal position, which requires memory storage plus executive control. N-back performance has been shown to be related to reasoning ability. This relationship becomes stronger as the task increases memory load (Salthouse, 2005).

**Anatomy and updating.** Several studies indicate that prefrontal activity is associated with updating tasks. During N-Back tasks, activity in lateral prefrontal cortex and parietal cortex increases with the value of N in a linear relationship (Braver et al., 1997). Another common task that taps into updating abilities is the letter-number sequencing task of the WAIS (Crowe, 2000). In a PET study where individuals performed the letter-number sequencing task, activations occurred in areas associated with working memory: the orbital frontal lobe, dorsolateral prefrontal cortex, and the posterior parietal cortex (Haut, Kuwabara, Leach, & Arias, 2000).

Functional imaging studies show left dorsolateral prefrontal activation for verbal working memory tasks and right dorsolateral prefrontal cortex activation for visuospatial tasks (Lezak, 2012), though this distinction may occur when executive demand for the task is low (Wager & Smith, 2003). Tasks involving continuous updating and temporal ordering show more activation in the superior frontal cortex but not inferior frontal activation, while other tasks such as manipulating items in working memory (ex. performing arithmetic on items in working memory) or dual task designs are not associated with superior frontal cortex activation (Wager & Smith, 2003). Continuous updating and temporal order memory (i.e., remembering order of items is part of the task) showed DLPFC and bilateral superior frontal sulcus (SFS) activation. Manipulation was associated with the ventral PFC and anterior PFC in the right hemisphere and the inferior frontal cortex, possibly because manipulation tasks involve inhibition and set-shifting in addition to working memory abilities (Wager & Smith, 2003). DLPFC activity is related to working memory load in an inverted U shape, with activity decreases as load gets very high (Callicott et

al., 1999). Selective attention has been suggested to limit the capacity of visual working memory because both attention and memory share neural resources (Linden, 2007).

**Inhibition and working memory.** Inhibitory control has been theorized to be one of the primary contributors of working memory abilities. One theory argues that the decision of which alternative action to choose is dependent on an interaction of working memory and inhibitory processes. Working memory is necessary to overcome the prepotent response by actively maintaining self-instruction (Roberts Jr & Pennington, 1996). The Stroop, for instance, is a task not ordinarily associated with working memory, but working memory is necessary to perform the task because the instructions need to be applied to the current context for each stimulus presented. Both working memory and inhibition tasks are related to activation in the inferior frontal gyrus, though separate regions of activation do exist such as the anterior middle right frontal region for inhibition tasks and the posterior middle right frontal region for working memory tasks, suggesting that these two processes may still be separable (McNab et al., 2008). The relationship between working memory and inhibition has been further demonstrated by a study where working memory capacity (WMC), as measured by the operation span, symmetry span, and reading span tasks, was related to inhibitory abilities, as measured by the go/no-go task (Redick, Calvo, Gay, & Engle, 2011). Individuals with lower working memory capacity as measured by the OSPAN test (where participants need to remember words while doing simple math problems), were less accurate and slower on an antisaccade task, while both groups performed equally on a prosaccade task (i.e., participants look in the direction of a cue) (Kane, Bleckley, Conway, & Engle, 2001). Additionally, individuals with higher WMC perform better on the Stroop (Kane & Engle, 2003).



**ERP literature and updating (P3b).** The P3b is an ERP component associated with working memory. The P3b does not reflect a specific process, as the P3b is elicited by a number of different tasks, suggesting it may be an index of processing efficiency (Bledowski et al., 2006). The P3b component has been traditionally proposed to be related to context updating (Polich, 1998). According to the context updating hypothesis, P3 amplitude reflects attentional and memory processes (Donchin & Coles, 1988; Polich, 1998), evaluation of a stimulus within a task and categorization of events or stimuli (Donchin, Kramer, & Wickens, 1986; Kok, 2001).

The P3b role in working memory performance is that it represents the decision of whether or not a stimulus matches an internal representation. P3b activity may reflect the comparison of external stimuli with the internal representations of the visuospatial sketchpad and the phonological loop (Bledowski et al., 2006; Kok, 2001). Working memory representations require updating when new information is presented (Donchin, 1981; Morgan, Klein, Boehm, Shapiro, & Linden, 2008). A memory comparison process determines whether the stimulus is the same or different from a previous encountered stimulus. If the stimulus is determined to be different, updating occurs and the P3b is elicited (Polich, 2003).

P3 elicited during the working memory task is different than the P3 elicited by the “oddball paradigm” as the P3 for working memory is divided into two peaks (an early peak, P366 and a late peak, P585). Early P3b is generated in the inferior temporal cortex, left temporo-parietal junction and the posterior parietal cortex (PPC) and the late is elicited from the PPC and the ventrolateral prefrontal cortex. In one study, early activity was sustained in the PPC, suggesting that this region is important for working memory, with its function most likely associated with the memory search process and operations on the storage buffer to evaluate stimuli. The late P3b showed a reduction of amplitude with higher working memory load, also

supporting other studies demonstrating memory load effects (Bledowski et al., 2006). Bledowski and colleagues (2006) suggest that in the context of working memory, the early P3b represents stimulus evaluation while the late P3b component may be related to memory search. A study using an n-back task found an association with working memory and an early (300ms) and late P3 (360ms) component. Using source analysis, the early P3 component was associated with the DLPC, VLPC, the inferior parietal lobule, medial posterior parietal and visual cortex. P3 amplitude decreased as working memory load increased (Nakao, Kodabashi, Yarita, Fujimoto, & Tamura, 2012). Decreased amplitude as the load increases has been found in other studies as well (Kok, 2001). One explanation of this is that more processing resources are used for memory maintenance so there are fewer processing resources available for stimulus evaluation (Morgan et al., 2008)

Updating is an executive component associated with the constant revision of working memory. Theories of working memory suggest an executive aspect in addition to simple storage buffers, allowing for the revision and manipulation of the contents in short term memory. The prefrontal cortex is associated with this executive component. Though there isn't a specific ERP component that is associated with updating, the P3b component may be used to look at updating performance, as the P3b may be a product of processing efficiency.

### **Problems With Current Clinical Executive Function Tasks**

There are several issues with the evaluation of executive function, partly because of the nature of executive function and lack of agreement of definition among those who study executive function. Stuss (2007) argued that the term executive function is broad and there are differences among the interpretations of the term in the field. Problems with the interpretation of the term executive function carry over to tasks of executive function. For instance, some tasks

that are considered to be “frontal”, have poor evidence for a relationship with frontal lobe function (Stuss, 2007; Stuss et al., 2001). Executive functions manifest themselves in different situations and work upon different stimuli (Burgess et al., 2006).

In a 2005 survey study of 747 neuropsychologists, the most commonly used tests of executive function were the Wisconsin Card Sorting Task (WCST), Rey-Osterrieth Complex Figure Test (ROCFT), Halstead Category Test, Trail Making Test, and the Controlled Oral Word Association Test (COWAT) (Rabin, Barr, & Burton, 2005). Strauss et al. (2006) outlined a number of issues with using these tests. The task impurity problem plagues many executive function tasks, meaning that differences in non-executive processing requirements may mask commonalities among executive function tasks. For instance, an executive function task that is verbal in nature may have different performance outcomes than a visual-spatial task, despite both tasks tapping into the same executive function component. Most tasks lead participants to use different cognitive operations (e.g., verbal or visuospatial processing) that are not directly related to the executive function of interest or are non-executive in general (Burgess et al., 2006; Miyake, Friedman, et al., 2000; Strauss et al., 2006). For example, the WCST involves multiple cognitive processes such as visual processing, basic numerical ability, rule induction, feedback processing, working memory, set-shifting, and motivation. Therefore, poor performance on WCST may not necessarily reflect deficits in executive function (Strauss et al., 2006). Additionally, executive function tasks are becoming increasingly complex. This complexity may mask the executive component being tested. Several authors have suggested the use of simpler tasks that better isolate the executive function of interest (Miyake, Emerson, et al., 2000; Stuss, 2007). Additionally, because there is evidence to suggest that executive functions are diverse and separable, assessment using only one task of executive function may not provide the whole

picture of whether or not an individual has an executive function deficit. Suppose an individual has difficulties with set-shifting, but updating abilities are unimpaired. Performance on an updating task will not reveal an executive function deficit (Miyake, Emerson, et al., 2000; Miyake, Friedman, et al., 2000; Strauss et al., 2006).

Validity arguments for tasks of executive function are sometimes weak. Miyake et al. pointed out that there is reliance on the WCST and The Tower of Hanoi task as classic measures of executive function, but construct validities have not been well established for these tasks. This problem partly arises because some choose to use tasks based on face validity rather than psychometric properties of the task (Strauss et al., 2006). In fact, many neuropsychological tasks used today were originally created for other purposes and task development was not construct driven (Burgess et al., 2006). Furthermore, there are low correlations among executive function tasks (Miyake, Friedman, et al., 2000). Low correlations among tasks may be due to the task impurity issue or because executive functions are separable in nature (Miyake et al. 2000). Inhibition, for example, has been shown to be a difficult construct to define and measure. Inhibition tasks have especially had the issue of low correlations among tasks, even with tasks designed to measure the same type of inhibition (Friedman & Miyake, 2004).

In addition to validity issues, scores from tasks of executive function suffer from low internal and/or test-retest reliability, possibly because individuals may adopt different strategies when performing tasks on different occasions (Miyake, Friedman, et al., 2000). Executive control is perhaps most important when tasks are novel, which may influence change in performance on subsequent testing trials (Miyake, Emerson, et al., 2000; Miyake, Friedman, et al., 2000). Low test-retest reliability limits test use for diagnostic purposes because determining change over time and pattern analysis can be problematic (Strauss et al., 2006).

To address some problems with executive function tasks, Stuss (2007) suggested that future research should be moving towards evaluating similarities and differences among executive functions. Miyake, Emerson, et al. (2000) indicated that it is important to specify the executive function that the test is measuring since not all executive functions are the same. To address the task impurity problem and attempt to isolate diverse executive components, several tasks evaluating the same executive function should be used and results should be integrated. Additionally, simpler tasks can also alleviate the issue of task impurity because mechanisms required to perform these tasks may be more easily understood and specific executive components can be more easily isolated.

### **Rationale of the Study**

Because of several issues with currently validated executive function tasks, there is a need to develop neuropsychological measures of executive function that address these issues. Thus, a new set of executive function measures is in the process of being developed (See Appendices A & B for test development and piloting information). The new measures were created to access the fundamental executive processes of inhibition, set-shifting, and updating as outlined by Miyake and colleagues (2000) and to address several problems with current executive function tasks. The benefit of assessing inhibition, set-shifting, and updating as opposed to higher order executive function is these three functions are highly specific and can therefore more easily be operationalized (Miyake, Emerson, et al., 2000). In addition to improving upon measures of executive function, the tasks were created to improve psychophysiological assessment as well, with the eventual goal of increasing sensitivity of psychophysiological assessment over behavior assessment alone. The tasks have also been created to work in conjunction with EEG to obtain ERPs. The tasks' stimuli are stationary arrows

(to prevent extra eye movements) and tasks have specific stimulus and response events that can be time locked to ERP components.

The task impurity issue described by Miyake et al. (2000) can be addressed by creating a set of executive function tasks that use the same stimulus set across each task because the same non-executive function processes will be used across tasks. Discrete executive functions become observable and isolated without the effect of perceptual differences among tasks. The new measures use colored arrows as stimuli, isolating the executive components and eliminating reliance on verbal processes, which benefits use in populations across varying cultures and education levels. The new set of measures will eliminate the interference of other processes during assessment, such as language processes, to get a more pure measure of executive function processes.

The measures can be adjusted (e.g., making stimuli appear slower on the screen) for assessment in several patient populations where executive function is compromised (e.g. traumatic brain injury patients, attention deficit disorder, dementia, and schizophrenia). Adjustments can be made to eliminate floor effects for dementia patients for instance, or eliminate ceiling effects if being used in normal populations.

Finally, performance is less susceptible to be faked or consciously manipulated because accuracy is quite high on average for the tasks (as demonstrated in piloting), so low accuracy performance may be a sign of poor effort or malingering. Additionally, ERP data may be difficult to manipulate.

## **Purpose of the Current Study**

The purpose of the study is to create and validate a new set of measures of executive function into simpler cognitive operation that have the same stimulus set. The study seeks to provide evidence of convergent and discriminant validity of the novel measures by examining relationships between the novel tasks and already established neuropsychological measures of executive function. Additionally, this study seeks to determine if the tasks are sensitive enough to elicit predicted ERP components. Because the executive components of inhibition, set-shifting, and updating are thought to be separable, performance on the novel tasks should correlate differently with the clinical EF measures theorized to measure different aspects of executive function and elicit different ERP components.

## **Hypotheses**

1. The same ERP components known to be associated with set-shifting, updating, and inhibition will also be elicited and associated with performance on the novel set of executive function measures.
  - a. The Nogo N2 (a frontocentral negative waveform with peak amplitude occurring around 200-400ms) and the Nogo P3 (a frontocentral positive waveform with peak amplitude occurring 250-500ms) will be elicited during tasks of inhibition. Additionally, during trials of inhibition (i.e., the Nogo trials of the Go/No-Go task and all trials of the Inhibit task) the Nogo N2 will have a larger negative amplitude than Go trials and Nogo P3 will have a larger positive amplitude than Go trials.
  - b. The P3a (a frontocentral waveform peaking around 250-500ms) and P3b (a parietal-central waveform peaking around 250-500ms) will be elicited during set-shift trials.

Both P3a and P3b will have a larger positive mean amplitude during shift trials than stay trials.

- c. The P3b (a parietal-central waveform peaking between 250-500ms) will have a larger positive amplitude during updating trials than the control trials. P3b amplitude will be associated with memory load in an inverted U-shape relationship.
2. The novel executive function tasks will be correlated with currently used, valid measures of executive function (clinical EF measures) to demonstrate convergent validity of the measures.
    - a. Performance on the tasks of inhibition (Inhibit and Go/No-Go) as measured by accuracy (ACC), reaction time (RT), and RT difference between control task and inhibit tasks will be correlated with Stroop Test performance (i.e., measured by Color-Word scores). Accuracy of the novel tasks will be positively correlated with the Stroop, while RT and RT difference will be negatively correlated with the Stroop.
    - b. Performance on the updating task (N-back) as measured by ACC, RT, and RT difference will be correlated with WAIS-IV Letter-Number Sequencing (LNS) performance (i.e., measured by longest span remembered and total score). Accuracy of the novel task will be positively correlated with LNS indices, while RT and RT difference will be negatively correlated with LNS indices.
    - c. Performance on the set-shifting task as measured by ACC, RT, and RT difference will be correlated with the Wisconsin Card Sorting Task (WSCT) performance (i.e., measured by number of categories completed, and number of preservative errors). ACC of the novel tasks will be positively correlated with WSCT scores, while RT and RT difference will be negatively correlated with WSCT scores. ACC will be



negatively correlated with Trail Making Part B (TMT-B) performance (i.e., time to complete) and RT and RT difference will be positively correlated with TMT-B performance.

## Chapter Two:

### Methods

#### Participants

Thirty-three undergraduate students were recruited from the University of South Florida's online subject pool (SONA) to participate in the study. Participants must have been between the ages of 18-30 to participate. Exclusion criteria included history of a neurologic disorder, current psychiatric illness, currently taking psychotropic medication, history of head injury, and history of extended loss of consciousness. Participants with hairstyles that may impede EEG sensor net to scalp contact were also excluded. Four participants (12.5%) did not meet the inclusion/exclusion criteria and were excluded from the study. Two of these excluded participants were over the age of 30, one participant was being treated for a psychiatric illness and one participant had history of loss of consciousness and head injury. Twenty-nine participants met inclusion/exclusion criteria. For the final sample, there were twenty-one females and eight males, ages 18-26 ( $M=21.66$ ,  $SD=2.24$ ), and years of education ranged from 13-19 ( $M=15.1$ ,  $SD=1.5$ ). Participants identified themselves as African American (20.7%), Asian (10.3%) Caucasian (55.2%), and Hispanic (13.8%).

#### Experimenters

Seven experimenters collected data for this study. Danielle Blinkoff administered the clinical EF measures to all 29 participants. The other six experimenters were undergraduate research assistants who work in either Dr. Cimino's or Dr. Potts's laboratory at the University of South Florida. The undergraduate RAs assisted in the EEG acquisition portion of the study. Two

experimenters collected EEG data as a pair. Each pair consisted of either two undergraduate research assistants or Danielle Blinkoff and a research assistant (with the exception of 3 participants for whom Danielle Blinkoff collected the EEG data on her own). Kyle Curham collected data for 11 participants, Rachel West collected data for 11 participants, Natalie Britton collected data for 12 participants, Mark DeMessa collected data for 8 participants, Alexandra Davis collected data for 3 participants, and Ashley Walker collected data for 4 participants. Training of the RAs consisted of review of the experimental protocol, EEG net handling and application, and E-Prime Software use. Danielle Blinkoff oversaw the first run of each RA pair to ensure the protocol was followed correctly.

## **Measures**

### **Neuropsychological Measures (Clinical EF Measures)**

**Wisconsin Card Sorting Task.** The purpose of this task is to assess the ability of abstract reasoning and set-shifting. Participants are given 60 cards with different symbols on each of them. Participants are required to sort the cards by using feedback given to them by the examiner (Berg, 1948; Grant & Berg, 1948). Miyake and colleagues found that performance on the WCST was predicted by shifting ability (Miyake, Emerson, et al., 2000; Miyake, Friedman, et al., 2000). Construct validity has been demonstrated for the WCST via concurrent and discriminant validities. Factor analysis studies indicate WCST taps into set-shifting, problem solving, and response maintenance (Greve, Stickler, Love, Bianchini, & Stanford, 2005; Strauss et al., 2006). WCST also has been shown to have predictive validity with impairment on the WCST being found in prodromal Parkinson's disease and Bipolar disorder patients (Strauss et al., 2006). Interrater reliability has been reported as .83 (Axelrod, Goldman, & Woodard, 1992;

Greve, 1993; Strauss et al., 2006). Test-retest reliability ranges from .37 to .72 in children (Heaton et al., 1993).

**Letter-Number Sequencing.** Letter-Number Sequencing (LNS) is a working memory subtest of the Wechsler Adult Intelligence Scale-IV (WAIS-IV) that assesses short-term auditory memory, auditory sequential processing, working memory, memory span, rote memory, and numerical ability. The examiner reads a list of numbers and letters and participants must mentally rearrange the list and state the numbers in order, following the letters in order (Lichtenberger & Kaufman, 2009; Sattler, Sattler, & Ryan, 2009). LNS is a reliable measure with internal consistency reliability ranging  $r=.85-.91$  and test-retest reliability ranging from  $r=.7-.81$  (Sattler et al., 2009; Strauss et al., 2006).

**Stroop Test.** The Stroop test is test of inhibition, where participants are given color words that are printed in different color ink and are required to state the color of the ink in which the word is printed. The test takes advantage of the brain's processing of words versus color identification (Golden & Freshwater, 1978). Test-retest reliability has been reported as .86 (Word), .82 (color), and .73 (Word-Color). The Stroop task has shown to have convergent validity with tasks of inhibition and processing speed, and has shown to have predictive validity of functional status in follow-up of vascular dementia patients (Strauss et al., 2006).

**Trail Making A & B.** This is a task involving scanning and visuomotor tracking, divided attention and cognitive flexibility. For Part A, participants draw lines to connect numbered circles in consecutive order as fast as possible. Part B requires participants to connect circles with numbers and letters by alternating between the two types of sets in consecutive order (Reitan & Wolfson, 1985). Test-retest reliability for part A has been shown to range from .46-.89 and .44-.87 for part B. Interrater reliability has been reported to be .94 for part A and .90 for Part

B (Fals-Stewart, 1991; Fals-Stewart, 1992; Strauss et al., 2006). Trail making has demonstrated validity, with relations to several other executive function tasks, particularly tasks of attention and set-shifting for Part B (Strauss et al., 2006). The test has also been shown to be sensitive to individuals with brain damage (Reitan, 1958).

### **The Novel Executive Function Tasks**

1. Control Task
2. Set-shifting Task
3. Inhibition Tasks
  - a. Inhibition Task 1: Incongruent Arrow Task
  - b. Inhibition Task 2: Go/No-Go
4. Updating Tasks
  - a. N-back

*See Appendix C for detailed descriptions of each task.*

### **Apparatus**

Brain electrophysiology was recorded using a 128-channel Electrical Geodesics system (EGI., Eugene, OR) sensor net in conjunction with NETSTATION 4.2 acquisition software powered by a Macintosh G4 computer. Electroencephalographic data was sampled at 250Hz, with .1-100 Hz analog filtering, referenced to the vertex. The novel executive function tasks were presented on a 19-inch, flat screen Dell Monitor. Screen resolution was 640 X 480. Tasks were programmed and presented on E-Prime Version 2.0 (PST Inc., Pittsburg). Responses were recorded on a number keypad [UP (8 key), DOWN (2 key), LEFT (4 key), and RIGHT (6 key)]. Keys were covered with arrows pointing in the appropriate direction.

## Procedure

Prior to experimental procedures, informed, written consent was obtained and participants had the opportunity to ask questions. Participants were assigned a subject number to protect confidentiality. Demographic information was obtained, which included gender, handedness, date of birth, and ethnicity. Information about current medications, psychological and neurological information was also obtained. After demographics were obtained, participants were then administered the group of clinical EF measures and the group of novel tasks in a counter-balanced order. Clinical EF measures (Wisconsin Card Sorting Task, Letter-Number Sequencing, Trail Making A & B and the Stroop Test) were administered in a randomized order.

EEG data was acquired while participants were administered the novel tasks. For the EEG acquisition portion of the study, an electrolyte solution consisting of 1 liter distilled H<sub>2</sub>O, 1.5 teaspoons of NaCl and .75 teaspoons of baby shampoo was prepared. The participant's head circumference was measured to find appropriate fitting EEG net. The net was submerged in the electrolyte solution. Head vertex was found and net was fitted. Net was adjusted until channel impedance was below 50k $\Omega$ . EEG acquisition took place in an electromagnetically shielded room. The set of the novel executive function tasks were administered to participants in a randomized order with the addition of the control task, which was always administered first, with 40 trials of each novel task condition given. The experimenter read the instructions for each task to the participant and provided the opportunity for the participant to ask questions. Once the session was complete, the EEG net was removed and sanitized. Participants were debriefed and given the opportunity to ask questions about the study.

## **ERP Extraction Procedure**

For each novel task the following steps were used to extract the ERP data: 1) Data was filtered offline at 20 Hz lowpass, 2) stimulus locked EEG data were segmented into 1000ms epochs, with 200ms pre- to 800ms post-stimulus onset (i.e., flash of the arrow), 3) Artifact detection and ocular artifact replacement was used to eliminate eye blinks, eye movement, bad channels and other non-cephalic artifacts, 4) data was sorted by condition and averaged to create the ERP, 5) baseline corrector was used over a 200ms baseline period to adjust the ERP to scale, 6) subject averaged ERPs were then averaged to create a grand average waveform to examine mean, medians and possible differences between conditions, and 7) waveforms was visually inspected by looking at scalp field topography (i.e., map of all electrodes and waveforms observed by each electrode) to determine temporal latency and electrodes used to extract ERPs where there appears to be effects among the conditions of interest. 8) Difference waves were created by subtracting waveforms of conditions of interest to determine epochs where there may be effects among conditions.

## Chapter Three:

### Results

Data were analyzed using IBM SPSS 21.0 for Windows and SAS 9.3 for Windows.

#### Behavioral Data (Novel Tasks Reaction Time) Diagnostics

All data was inspected for missing data points. One participant had missing data for the Set-Shift and Inhibit tasks due to equipment failure. One participant had missing data for the N-back task because the participant misunderstood the task. List-wise deletion was used to handle all missing data. For each novel executive function task, only trials with correct responses were examined and used in the final analysis of reaction time data (see Table 1 for percent correct for each novel task condition).

Table 1

*Percent Accuracy For All Novel Tasks*

Task/Condition	Percent Correct Across Participants
Control	98.19%
Inhibit	97.77%
Go	98.7%
No-Go	99.91%
Stay (Congruent)	96.8%
Stay (Incongruent)	97%
Shift (Congruent)	95.2%
Shift (Incongruent)	97.4%
1-back	92.05%
2-back	65.54%
3-back	39.11%



### **Examination of Outliers: Individual Participants By Condition**

Reaction time data were examined for outliers for each individual participant within each novel task. Reaction time values that were above or below 2 standard deviations from that participant's mean were deemed outliers and were removed.

### **Examination of Normality and Outliers: Participants By Overall Mean of Condition**

After removal of outliers for each individual participant per condition, descriptive statistics and skewness and kurtosis were calculated for each condition. Guidelines by Field (2005) were used for significance tests of skewness and kurtosis for each novel task by transforming skew and kurtosis values to z-scores. Any z-score of an absolute value greater than 1.96, was deemed as significantly deviating from a kurtosis and skewness of 0 ( $p < .05$ ) because normal distributions have skewness and kurtosis values of 0, therefore, values deviating from 0 indicate violations to normality (see Table 2). Mean reaction times for each participant per task condition were calculated to determine if any individual participant's mean was an outlier compared to the overall group of participants for that specific condition. Data were visually inspected using box and whiskers plots. Additionally, mean reaction times were also converted to z-scores. Z-scores with absolute values greater than 1.96 ( $p < .05$ ), or 2 *SD* below or above the grand mean were deemed to be outliers (see Table 3). Descriptive statistics and skewness and kurtosis were then recalculated with the outliers removed (see Table 4).

Table 2

*Descriptive Statistics of Novel Measures (Including Outliers)*

	<i>N</i>	Mean	<i>SD</i>	Skewness	Kurtosis
Control Acc	29	39.27	0.96	-1.13*	0.85
Control RT		450.50	97.89	0.44	-0.71
Inhibit Acc	28	39.11	1.55	-2.71*	8.73*
Inhibit RT		534.62	131.19	1.07*	2.26*
Go Acc	29	39.48	0.91	-1.77*	2.26*
Go RT		515.89	99.27	0.04	-0.36
NoGo Acc		39.97	0.19	-5.39*	29
1 Back Acc	28	36.82	3.28	-2.56*	8.153*
1 Back RT		451.81	220.27	.578	-.849
2 Back Acc	28	26.54	11.1	-0.78	-0.68
2 Back RT		468.55	243.87	0.99*	0.05
3 Back Acc	28	15.64	8.79	1.06*	0.34
3 Back RT		526.75	268.8	0.88*	0.02
Stay RT	28	623.33	127.77	0.49	-0.55
Shift RT		643.21	128.69	0.31	-0.51
<i>Stay Congruent RT</i>		<i>600.73</i>	<i>123.29</i>	<i>0.46</i>	<i>-0.71</i>
<i>Stay Incongruent RT</i>		<i>649.08</i>	<i>143.76</i>	<i>0.70</i>	<i>-0.23</i>
<i>Shift Congruent RT</i>		<i>638.94</i>	<i>133.02</i>	<i>0.60</i>	<i>0.12</i>
<i>Shift Incongruent RT</i>		<i>647.96</i>	<i>127.42</i>	<i>0.05</i>	<i>-0.93</i>

\*Indicates a significant deviation from normal at  $p < .05$

Table 3

*Data Points Identified as Outliers at  $p < .05$  for the Novel Tasks (RT)*

<b>Variable</b>	<b>Participant</b>	<b>Value</b>	<b>Z-Score</b>
Control	102	656.8	2.11
Inhibit	102	949.13	3.16
Go	102	721.25	2.07
1 Back	129	903.15	2.05
2 Back	126	1048.86	2.38
	129	979.71	2.1
3 Back	129	1150	2.53
Stay	102	905.26	2.21
Shift	102	930.69	2.23

Table 4

*Descriptive Statistics of RT of Novel Measures (with RT outliers removed)*

	<i>N</i>	Mean	<i>SD</i>	Skewness	Kurtosis
Control RT	28	443.13	91.13	0.37	-0.87
Inhibit RT	27	519.27	104.97	0.10 <sup>+</sup>	-0.90 <sup>+</sup>
Go RT	28	508.56	92.74	-0.13	-0.47
1 Back RT	27	435.09	205.58	0.57	-0.87
2 Back RT	26	426.57	196.16	0.87 <sup>+</sup>	-0.13
3 Back RT	27	484.23	224.49	0.84 <sup>+</sup>	0.34
Stay RT	27	612.89	117.4	0.38	-0.75
Shift RT		632.56	117.91	0.11	-0.86
<i>Stay Congruent RT</i>		<i>591.44</i>	<i>115.21</i>	<i>0.41</i>	<i>-0.72</i>
<i>Stay Incongruent RT</i>		<i>637.14</i>	<i>131.60</i>	<i>0.64</i>	<i>-0.24</i>
<i>Shift Congruent RT</i>		<i>626.33</i>	<i>117.25</i>	<i>0.24</i>	<i>0.76</i>
<i>Shift Incongruent RT</i>		<i>639.10</i>	<i>120.74</i>	<i>-0.02</i>	<i>-1.00</i>

\*Indicates significantly different from normal at  $p < .05$

<sup>+</sup> Indicates no longer deviation from normality due to removal of outlier

### **Multivariate Normality and Outliers for RT Data**

Tests of multivariate normality were also conducted for the novel tasks. Tests of the multivariate normality assumption suggested there was a statistically deviation of multivariate skewness and kurtosis,  $B_{1p}=30.31$ ,  $\chi^2(120, N=27)=155.26$ ,  $p=.017$ ;  $B_{2p}=81.89$ ,  $z_{upper}=.389$ ,  $z_{lower}=-4.99$ , however multivariate repeated measures ANOVA is generally robust to violations of multivariate normality. The data was also examined for multivariate outliers. Upon analyzing the data, a multivariate outlier was found ( $p=.009$ ), though the Mahalanobis distance of this record is not much larger than that the other records ( $D^2=15.7$ , participant 111). Analysis was conducted with and without univariate outliers for each task. Since there was no difference in outcome, results include all data points.

The same data analysis completed during piloting (see appendix A) was conducted with the data collected for this current sample of participants to determine if there were reaction time differences among the novel tasks. Reaction time is one way of indexing task difficulty, with the

expectation that more difficult tasks will be associated with longer response times because the brain will take a longer time to process information (Sternberg, 1969). Because differences in reaction time is an indicator of a cognitive operation at work (Burgess et al., 2006), and there are certain expectations about difficulty differences between certain conditions, examining reaction time is one way to support validity of the tasks.

### **Multivariate Analysis for RT Data**

A one-way multivariate-repeated measures ANOVA was used to examine differences in mean reaction time (dependent variable) across task conditions (independent variable): Control, Inhibit, Go, 1 Back, 2 Back, 3 Back, Stay and Shift. List-wise deletion was used to handle missing data. The difference in mean reaction time across conditions was statistically significant  $A=.171$ ,  $F(7,20)=13.889$ ,  $p<.001$ ., and the multivariate effect size was estimated to be  $\hat{\omega}_c^2=.684$ .

Univariate follow-up tests (pair-wise t-tests) using a Bonferroni approach ( $p<.0125$ ) to reduce family-wise error were conducted to examine differences between the executive function condition and control condition (list-wise deletion was used to handle missing data). Pairwise t-tests revealed significant differences between the Control Task and Inhibit Task  $t(27)=-4.226$ ,  $p<.001$  (Figure 1), the Control and Go Conditions  $t(28)=-4.345$ ,  $p<.001$ (Figure 2), and Stay and Shift Conditions  $t(27)=-2.989$ ,  $p<.01$  (Figure 3). The effect sizes were large for Go/No-Go ( $d=.81$ ) and medium for the Inhibit ( $d=.799$ ) and Set-shift ( $d=.56$ ) task comparisons. To examine effect of memory load on reaction time, a multivariate repeated measures ANOVA revealed no significant differences between the Control Task, and 1, 2, and 3 Back conditions,  $A=.911$ ,  $F(3,25)=.814$ ,  $p=.498$  (figure 4).

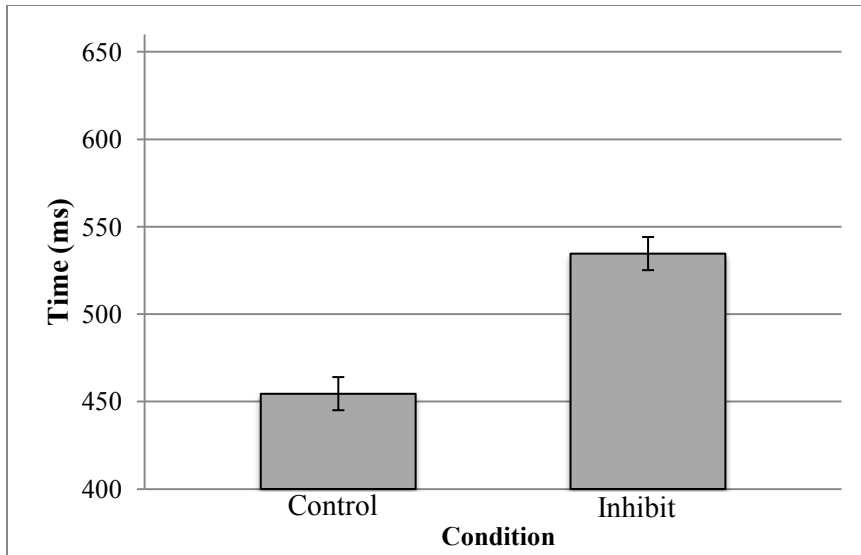

\* Error bars denote standard error of the mean

Figure 1

*Mean RT for Inhibit Vs. Control Conditions*

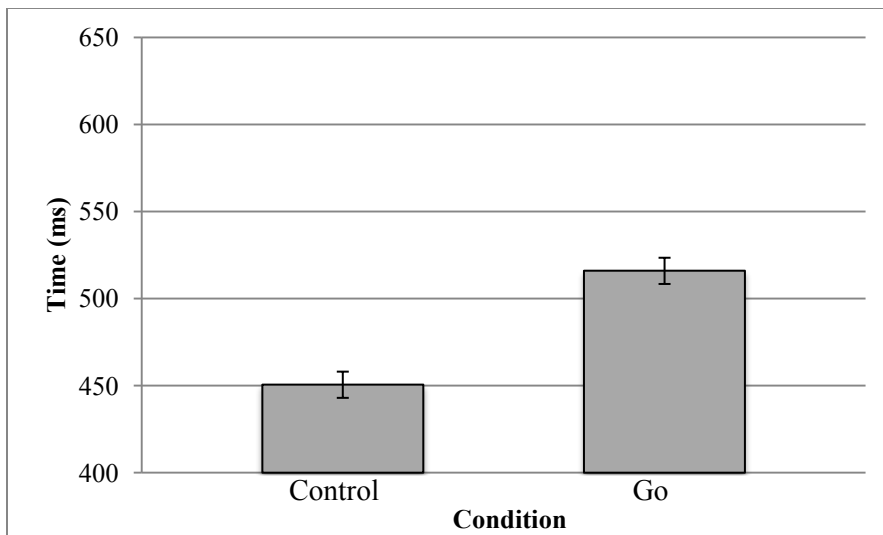

\*Error bars denote standard error of the mean

Figure 2

*Mean RT for Go Vs. Control Conditions*

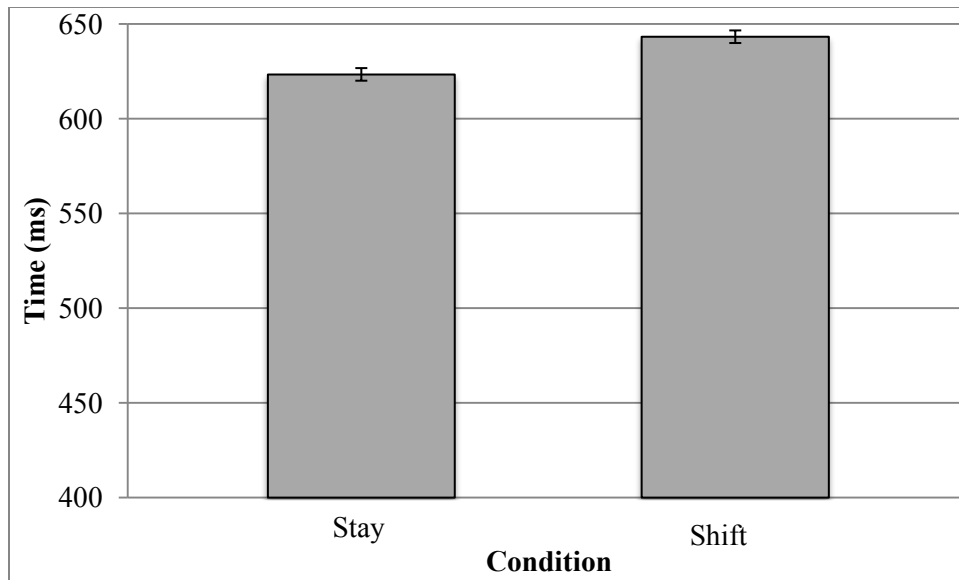

\* Error bars denote standard error of the mean

Figure 3

*Mean RT for Shift vs. Stay Conditions*

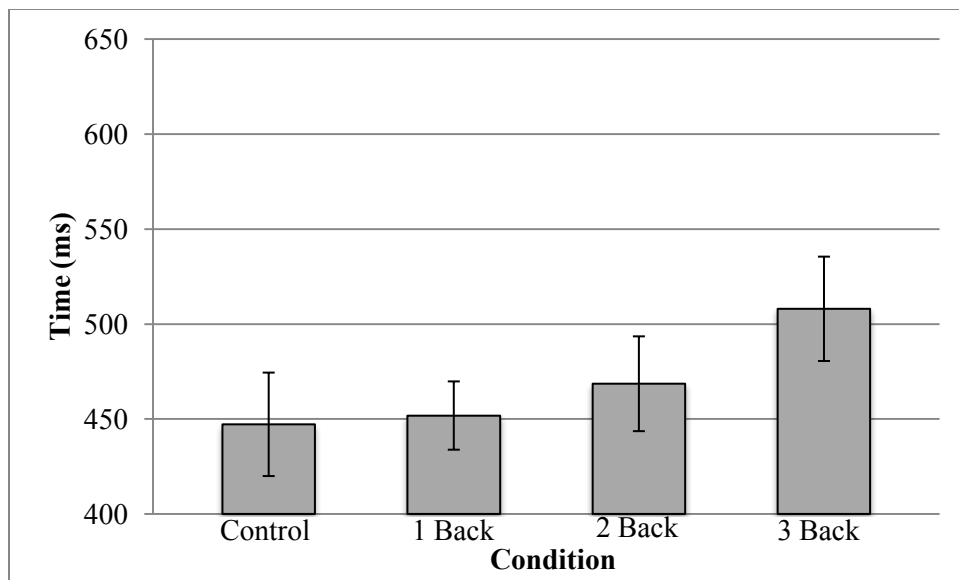

\* Error bars denote standard error of the mean

Figure 4

*Mean RT For Memory Load*

Because the Set-Shift task required participants to switch between “congruent” and “incongruent” conditions, a separate analysis of reaction time differences between the two conditions was conducted to determine if conditions were equal in difficulty. Using a pair-wise t-

test with condition as the independent variable and reaction time as the dependent variable, incongruent trials ( $M = 632.83$ ,  $SD = 124.79$ ) were associated with a longer mean reaction time than congruent trials ( $M = 610.94$ ,  $SD = 123.29$ ),  $t(27) = 3.12$ ,  $p < .01$ ,  $d = .59$  (figure 5).

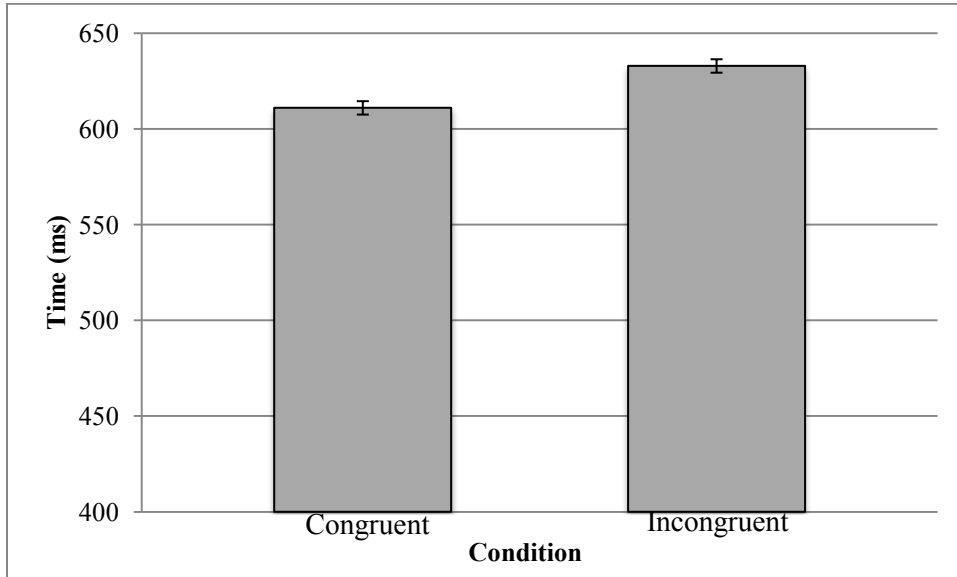

\* Error bars denote standard error of the mean

Figure 5

*Mean RT for Congruent vs. Incongruent Conditions*

### N-Back Accuracy Analysis

Because accuracy was not at ceiling for the N-back tasks and there were no differences in reaction time among conditions, further analysis of the effect of memory load on accuracy was conducted. Tests of multivariate normality were conducted on accuracy scores for memory load conditions. Tests of multivariate normality assumption suggests there was a statistically significant deviation of skewness,  $B_{1p} = 12.26$ ,  $\chi^2(20, N = 28) = 66.07$ ,  $p < .01$ ;  $B_{2p} = 27.46$ ,  $z_{upper} = 1.32$ ,  $z_{lower} = -.308$ . Multivariate repeated measures ANOVA is generally robust to violations of multivariate normality. A multivariate outlier was found ( $p < .001$ ,  $D^2 = 17.12$ , participant 116), but was left in the analysis. A multivariate repeated measures ANOVA revealed a

significant difference in accuracy,  $A=.103$ ,  $F(3,25)=72.23$ ,  $p<.001$ , and the multivariate effect size was estimated to be  $\hat{\omega}_c^2=.87$ .

Univariate follow-up tests (pair-wise t-tests), using a Bonferroni correction ( $p<.017$ ), were used to examine which control and experimental conditions differed in accuracy. The control task accuracy ( $M=39.29$ ,  $SD=.98$ ) was significantly higher than one back accuracy ( $M=36.82$ ,  $SD=3.277$ ),  $t(27)=4.12$ ,  $p<.001$ , (effect size,  $d=.78$ ), one back accuracy was significantly higher than two back accuracy ( $M=26.54$ ,  $SD=11.1$ ),  $t(27) 4.955$ ,  $p<.001$  (effect size,  $d=.94$ ), and two back accuracy was significantly higher than three back accuracy ( $M=15.64$ ,  $SD=8.78$ ),  $t(27) 4.79$ ,  $p<.001$  (effect size,  $d=.91$ ) (see figure 6).

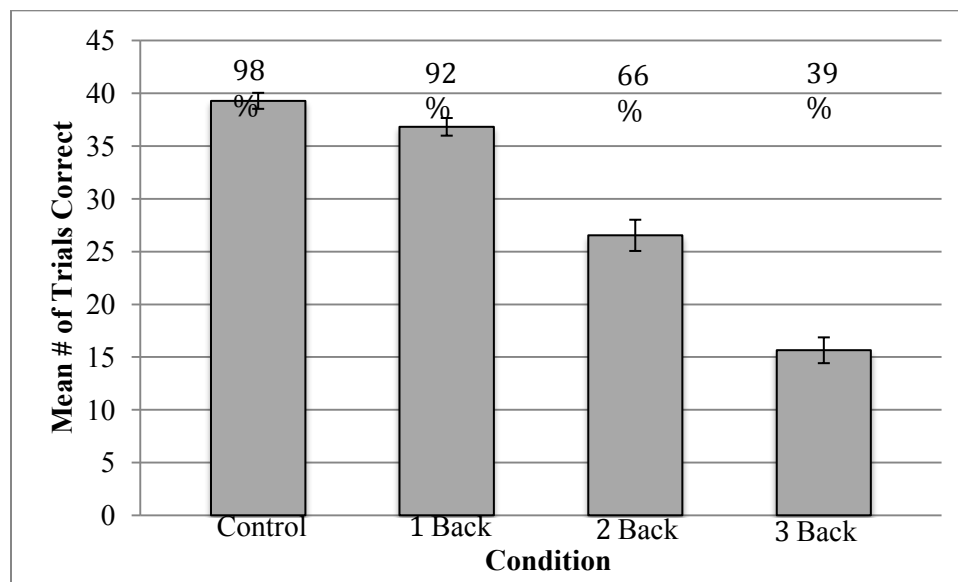

\* Error bars denote standard error of the mean

Figure 6

*N-Back Mean Accuracy (Out of 40 Trials) and Percentage of Correct Trials*

### Neuropsychological Task Diagnostics (Clinical EF Measures)

Descriptive statistics and skewness and kurtosis were calculated for the raw scores from the clinical EF measures (see Table 5). Data was inspected for missing data points. List-wise deletion was used to handle missing data. For the clinical EF measures, one participant had



missing Letter-Number Sequencing scores because the participant's first language was not English. Two participants had missing WSCT data due to experimenter error in administering the task. The same procedures for outlier identification used for the reaction time data of the novel tasks were also used for clinical EF measures (see Table 6 for data points identified as outliers).

Table 5  
*Descriptive Statistics of the Clinical EF Measures (Outliers Included)*

	<i>N</i>	Mean	<i>SD</i>	Skewness	Kurtosis
TMT-A (seconds)	29	22.91	9.97	2.11*	6.46*
TMT-B (seconds)	29	55.26	27.32	2.66*	9.51*
Stroop Color-Word	29	48.82	9.57	-0.16	-0.82
LNS Total Score	28	20.71	2.42	0.02	-0.77
LLNS	28	5.71	0.90	-0.04	-0.77
WSCT Total	27	51.00	9.03	-1.87*	2.69*
WSCT Categories Complete	27	4.11	1.22	-1.46*	1.45

\* Indicates significantly different from normal at  $p < .05$

Table 6  
*Data Points Identified as Outliers at  $p < .05$*

Variable	Participant	Value	Z-Score
WSCT Total Score	109	28	-2.55
	126	25	-2.88
WSCT Categories Correct	109	1	-2.55
	126	1	-2.55
TMT-A	131	60.72	3.79
TMT-B	116	167.16	4.10

Descriptive statistics, skewness and kurtosis were recalculated for clinical EF measure scores with outliers removed (Table 7).

Table 7  
*Descriptive Statistics of the Neuropsychological Measures (Outliers Removed)<sup>1</sup>*

	<i>N</i>	Mean	<i>SD</i>	Skewness	Kurtosis
TMT-A	28	21.56	6.96	0.71 <sup>+</sup>	-0.01 <sup>+</sup>
TMT-B	28	51.27	17.14	0.86 <sup>+</sup>	-0.10 <sup>+</sup>
WSCT Total	25	52.96	5.842	-1.87*	3.15*
WSCT Categories Complete	25	4.36	0.86	-1.46*	0.86

\* Indicates significantly different from normal at  $p < .05$

<sup>+</sup> Indicates change in normality due to removal of outlier

<sup>1</sup> Only variables where outliers were removed are listed.

## EEG Data Diagnostics

Two participants did not have EEG data to analyze. One participant's head circumference was larger than available nets, and therefore, the participant completed tasks without the EEG net. The other participant had thick hair that did not allow for proper net to scalp contact and impedance was unable to be brought below 50k $\Omega$ . Therefore twenty-seven participants' data was available for analysis. For each condition of the novel tasks, participants' data was included in the analysis if there were 20 clean trials. Trials were considered clean if there were no non-cephalic artifacts such as eye blinks and the participant responded correctly during that trial. The 3-Back condition was eliminated from analysis because only six participants had 20 clean trials. Fifteen participants were used in N-back analysis because participants needed 20 clean trials for both 1-back and 2-back tasks to be included in the analysis. See Table 8 for final number of participants included in the ERP analysis.

Table 8

### *Participants Included in ERP analysis*

<b>Task/Condition</b>	<b>Number of Participants Included in Final Analysis</b>
Control	27
Inhibit	24
1-Back	15 (23 clean)
2-Back	15 (18 clean)
Go/NoGo	24
Set-Shift	22

### **RT Data for Participants Included in ERP Analysis**

Reaction time data were reanalyzed to determine if there were differences between conditions for participants that were included in the ERP analysis (Table 8). Results that were statistically significant for the larger group of participants remained significant and means were in the same direction for the participants included in the final ERP analysis (Control faster than Inhibit  $t(23)=3.74, p <.001$ ; Control faster than Go  $t(22)=3.72, p <.001$ ; Stay faster than Shift  $t(22)=2.73, p <.05$ ). N-back reaction time differences remained non-significant across the Control, 1-Back, 2-Back, and 3-Back conditions  $A=.897 F(3,14)=.537, p=.66$ , and a significant difference in accuracy among the conditions remained  $A=.125 F(3,14)=32.62, p <.001$ .

### **ERP Analysis Procedures**

As this was an exploratory study, the grand average for each condition was visually inspected for each electrode. Groups of electrodes that showed waves as having similar forms were grouped together to form a montage of electrodes that was used for analysis. ERP waves were then created from the average of that group of electrodes. The ERP wave was then inspected to determine epochs that may have a significant difference from one another. Difference waves were also created for each condition of interest to determine points in the wave where the biggest effects lie. Mean Amplitude was used for comparisons of each condition of interest. Waveforms were analyzed by region of interest where all electrodes in a particular region were averaged. The advantage of this technique improves ease of interpretation as it provides a better fit to ANOVA and MANOVA models (Handy, 2004).

## Hypothesis 1 Data Analysis

*The same ERP components known to be associated with inhibition, set-shifting, and updating, will be elicited and associated with performance on the novel set of executive function measures.*

For analysis of this hypothesis, the independent variable is task condition and the dependent variable is mean amplitude [(measured in microvolts “ $\mu\text{V}$ ”) within a specific epoch/time window (measured in milliseconds “ms”)].

### Inhibition Hypothesis

The Nogo N2 (a frontocentral negative wave form with peak amplitude occurring around 200-400ms) and the Nogo P3 (a frontocentral positive wave form with peak amplitude occurring 250-500ms) will be elicited during tasks of inhibition. Additionally, during trials of inhibition (i.e., the Nogo trials of the Go/No-Go task and all trials of the Inhibit task) the Nogo N2 will have a larger negative amplitude and Nogo P3 will have a larger positive amplitude than in the Go trials.

**Inhibit task results.** The following electrode montage was used to examine frontal ERP activity for this task: 4, 5, 6, 10, 11, 12, 13, 15, 16, 18, 19, 21, 112. Several time points were identified by visually inspecting the waveforms and difference waveforms for possible significant effects (288-328ms, 300-530ms, 400-500ms, 544-716ms). There were no significant differences in ERP mean amplitude between the two conditions for any epoch examined (Figure 7). Specifically, when looking at the time point which would correspond to the NoGo-P3 (300-530ms epoch), there were no significant differences in mean amplitude between the inhibit ( $M=-1.3$ ,  $SD=2.69$ ) and control condition ( $M=-1.46$ ,  $SD=2.43$ ),  $t(23)=-.310$ ,  $p=.76$ . A more restrictive

epoch from 400-500ms was also analyzed, but results also revealed no significance between the control ( $M=-1.87$ ,  $SD=2.63$ ) and inhibit ( $M=-1.64$ ,  $SD=2.89$ ) conditions  $t(23)=-.431$ ,  $p=.67$ ).

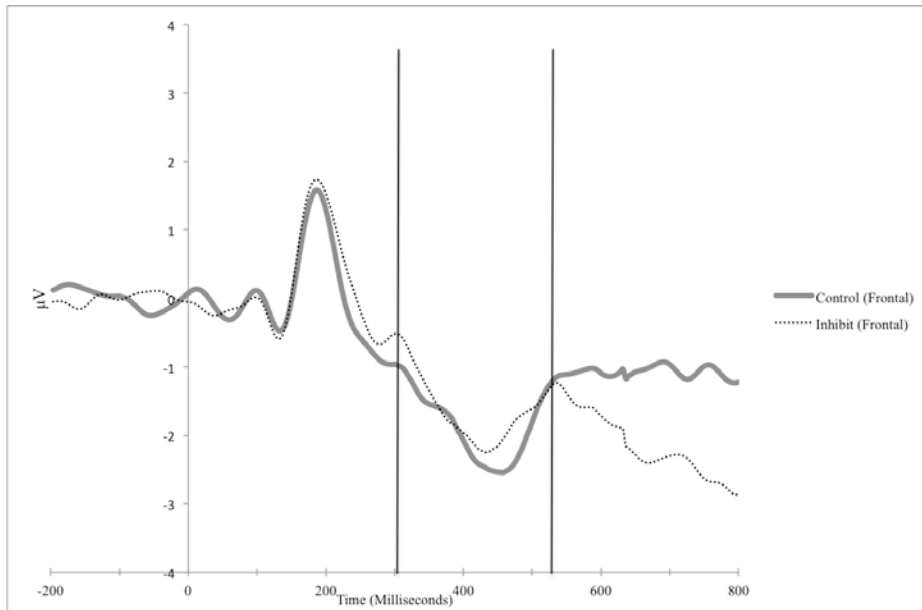

Figure 7

*Frontocentral Waveform for the Inhibit Task with Vertical Lines Indicating the 300-530ms Epoch.*

The following electrode montage was used to examine posterior ERP activity for this task: 60, 66, 67, 70, 71, 72, 75, 76, 77, 83, 84, 85. There were no significant differences between the two ERP mean amplitudes for any epoch analyzed (260-560ms, 276-356ms, 496-724ms). Specifically, when examining the epoch corresponding with the P3b (260-560ms), there were no significant differences in mean amplitude between the control ( $M=1.186$ ,  $SD=2.84$ ) and inhibit ( $M=1.299$ ,  $SD=2.43$ ) conditions  $t(23)=.187$ ,  $p=.853$  (figure 8).

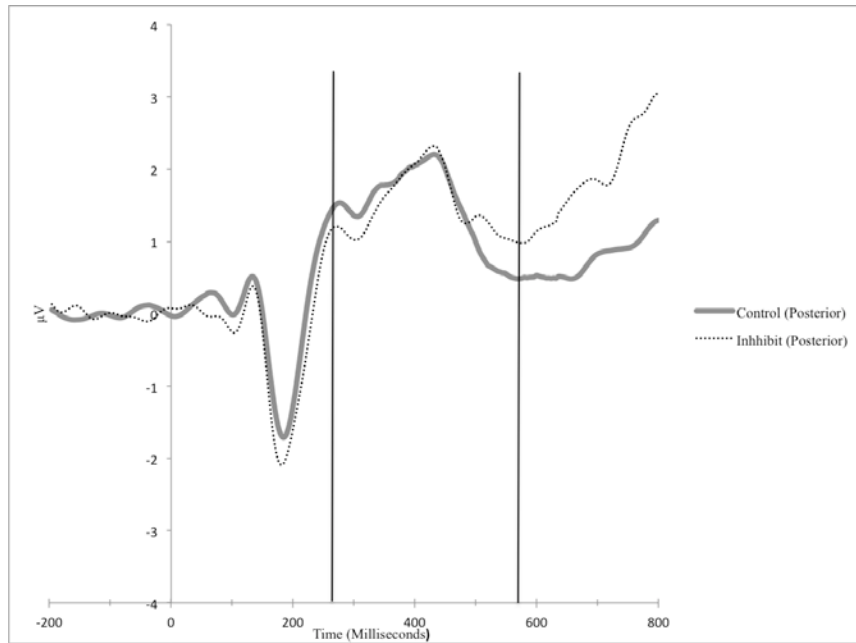

Figure 8

*Posterior-Central Waveform for the Inhibit Task with Vertical Lines Indicating the 260-560ms Epoch.*

**Go/ No-Go task results.** The following electrode montage was used to examine frontal ERP activity for this task: 4, 5, 6, 10, 11, 12, 15, 16, 18, 19. Results revealed a significant effect for the 130-280ms epoch,  $t(23)=2.591, p<.05$ , indicating Go trials ( $M=1.05, SD=1.25$ ) led to a significantly more positive wave form than No Go trials ( $M=.27, SD=1.17$ ). There was also a significant effect for the epoch corresponding to P3 amplitude (310-520ms)  $t(23)=4.162, p<.001$ , with NoGo trials ( $M=-.45, SD=2.63$ ) leading to a significantly more positive waveform than Go trials ( $M=-2.41, SD=2.56$ ) (See Figure 9).

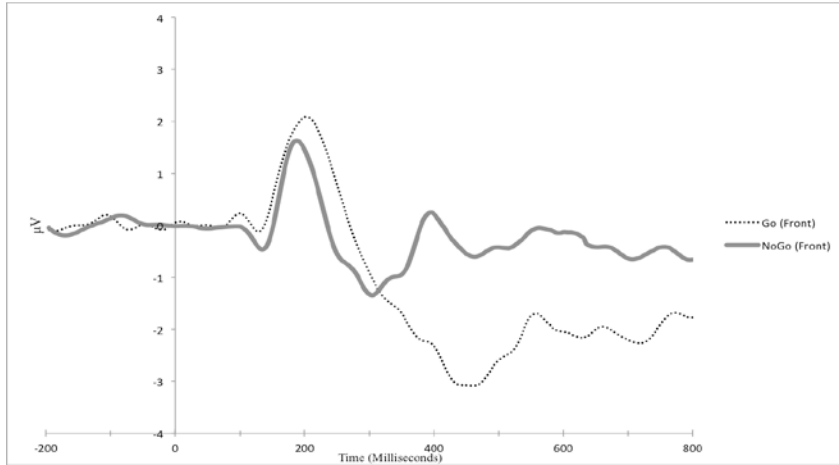

Figure 9

*Frontocentral Waveform for the Go/No-Go Task with Vertical Lines Indicating the 130-280ms and 310-520ms Epochs.*

The following electrode montage was used to examine posterior ERP activity for this task: 60, 66, 67, 70, 71, 72, 75, 76, 77, 78, 83, 84, 85. Results revealed a significant difference in mean P3b amplitude (240-540ms epoch)  $t(23)=3.107, p<.01$ , indicating Go trials ( $M=1.54, SD=1.78$ ) led to a significantly more positive wave form than No-Go trials ( $M=.34, SD=1.67$ ) (Figure 10). This result is inconsistent with the hypothesis for this task.

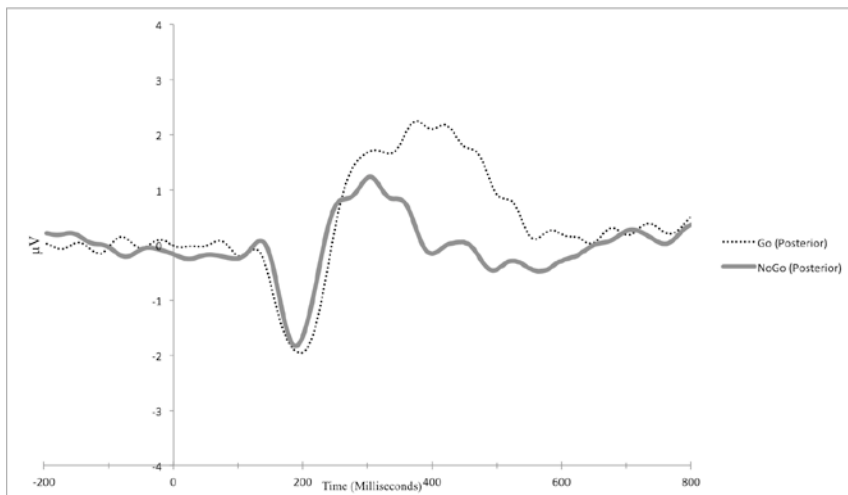

Figure 10. *Posterior Waveform for the Go/No-Go Task 240-540ms Epoch.*

## Set-Shift Hypothesis

*The P3a (a frontocentral waveform peaking around 250-500ms) and P3b (a parietal-central wave form peaking around 250-500ms) will be elicited during set-shift trials. Both P3a and P3b will have a greater positive mean amplitude during shift trials than stay trials.*

**Set-shift results.** The following electrode montage was used to examine frontal ERP activity for this task: 5, 6, 10, 11, 15, 16, 18, 19, 20. The epochs corresponding to P3a amplitude (310-480ms) yielded non-significant results  $t(21)=1.648$ ,  $p=.114$ , between shift ( $M=-2.41$ ,  $SD=3.1$ ) and stay ( $M=-1.89$ ,  $SD=3.73$ ) trials. There were no additional significant effects found for other epochs examined (480-608ms epoch:  $t(21)=1.01$ ,  $p=.286$ ) (figure 11).

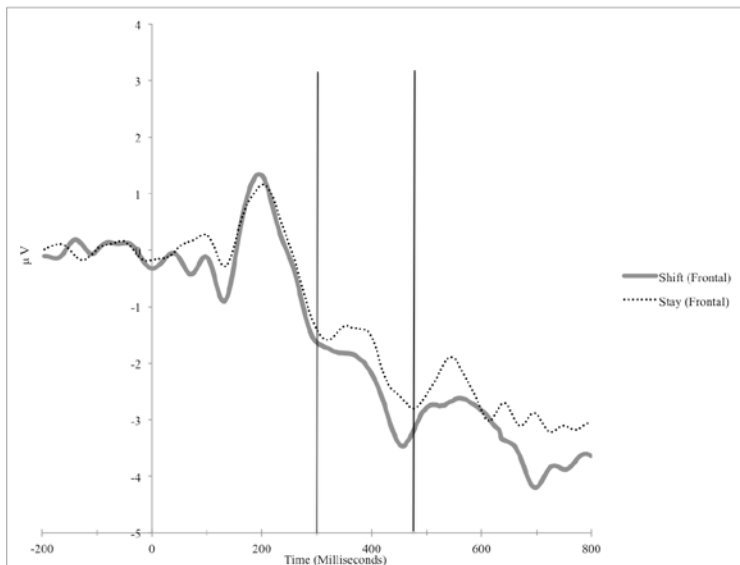

Figure 11

*Frontocentral Waveform for the Set-Shift task with Vertical Lines Indicating the 310-480ms Epoch.*

There was no significant effect between stay and shift trials for posterior electrodes (electrode montage: 60, 66, 67, 70, 71, 77, 79, 83, 84, 85, 86) for any epoch analyzed (172-



204ms epoch:  $t(21)=1.71, p=.101$  and 272-256ms epoch:  $t(21)=1.7, p=.105$ ), which indicated no significant difference in P3b amplitude (Figure 12).

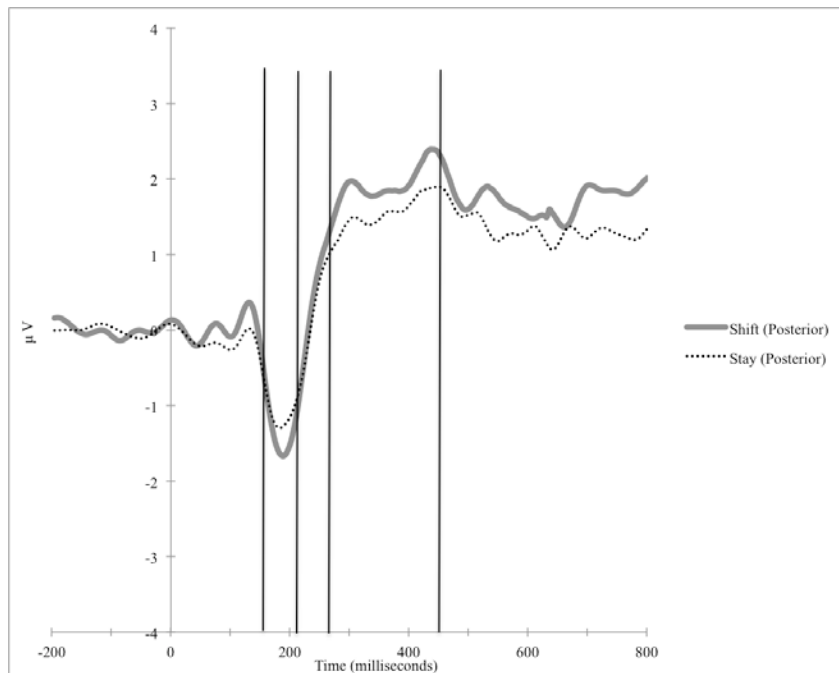

Figure 12

*Parietal-Central Waveform for the Set-shift Task with Vertical Lines Indicating the 115-140ms and 272-456ms Epochs.*

Because there were two different trial types in the set-shifting task (congruent vs. incongruent trials), exploratory analyses were conducted to examine differences between congruent and incongruent trial types. The same frontal and posterior electrode montages used for shift vs. stay trial analysis. There were no significant differences between congruent and incongruent trials for any epoch analyzed (176-228ms:  $t(21)=1.35, p=.19$ , 300-424ms:  $t(21)=1.39, p=.18$ , and 496-560ms:  $t(21)=1.06, p=.3$ ) (Figure 13).

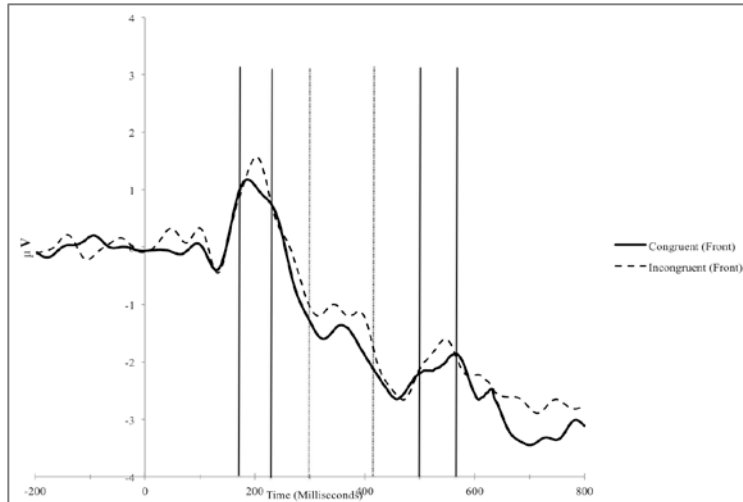

Figure 13

*Frontal Waveform for the Set-shift Task Examining Congruent and Incongruent Trials with Vertical Lines Indicating the 176-288ms, 300-424ms, and 496-560ms Epochs.*

There were no significant differences between congruent and incongruent trials for any epoch (116-144ms:  $t(21)=1.3$ ,  $p=.21$ , 292-320ms:  $t(21)=.21$ ,  $p=.84$ , and 400-484ms:  $t(21)=.74$ ,  $p=.47$ ) analyzed for the parietal-central electrodes (figure 14).

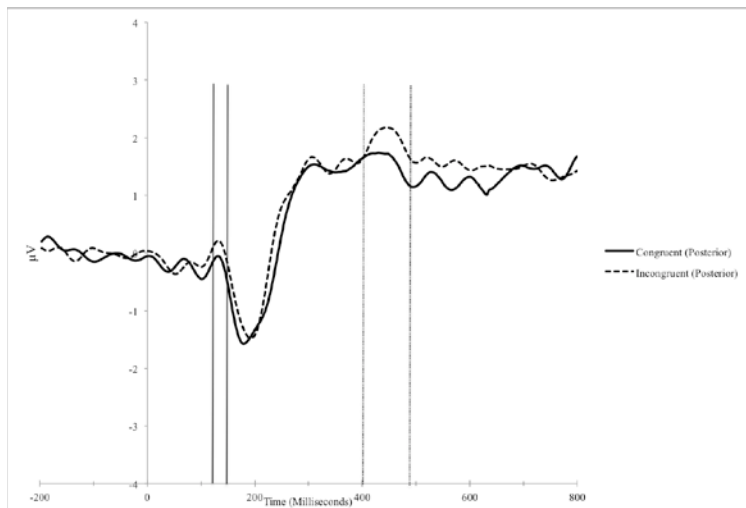

Figure 14

*Posterior Waveform for the Set-Shift Task Examining Congruent and Incongruent Trials with Vertical Lines Indicating the 116-144ms and 400-484ms Epochs.*

### **Updating (N-Back)-Hypothesis**

*The P3b (a parietal-central waveform peaking between 250-500ms) will have a larger positive amplitude during updating tasks than the control task. ERP elicitation will be associated with memory load in an inverted U-shape relationship.*

**Updating (N-Back) results.** The following electrode montage was used to examine posterior ERP activity for this task: 60, 62, 66, 67, 71, 72, 76, 77, 83, 84, 85. A one-way multivariate repeated measures ANOVA was used with condition as the independent variable and mean amplitude as the dependent variable, as three different conditions were compared to test this hypothesis. Results revealed a significant effect for P3b mean amplitude (248-472ms epoch),  $A=.461$ ,  $F(2,13)= 5.57$ ,  $p<.05$  indicating a difference in P3b mean amplitude due to memory load. Univariate follow-up tests (pairwise t-tests) were conducted to determine which specific conditions differed from one another. Results revealed the 1 Back condition ( $M=1.31$ ,  $SD=1.26$ ) elicited a larger positive amplitude than the 2 Back condition ( $M=.55$ ,  $SD=1.37$ ),  $t(14)=2.62$ ,  $p<.05$ . There a trending effect in which the Control condition ( $M=1.83$ ,  $SD=2.82$ ) elicited a larger positive amplitude than the a 2 Back ( $M=.55$ ,  $SD=1.37$ ) conditions  $t(14)=1.92$ ,  $p=.076$  (Figure 15). This suggests that P3b performance was related to memory in a linear relationship rather than U-shaped.

Exploratory analysis was also completed to determine if there were differences in amplitudes in frontal electrodes (montage used: 6, 11, 15, 16, 18, 19, 22, 23). Using a one-way multivariate repeated measures ANOVA with condition as the independent variable and mean amplitude as the dependent variable, results revealed a significant difference in mean ERP amplitude for the 168-208ms epoch,  $A=.402$ ,  $F(2,13)= 4.328$ ,  $p<.05$ . Univariate follow-up tests (pairwise t-tests) revealed a significant difference in amplitude between the Control ( $M=1.42$ ,

$SD=1.78$ ) and 2 Back ( $M=.25$ ,  $SD=1.48$ ) conditions,  $t(14)=2.945$ ,  $p<.05$ , with the control condition eliciting a more positive mean ERP amplitude than the 2 Back condition. A significant difference was also revealed for the 252-468ms epoch,  $A=.394$ ,  $F(2,13)= 4.22$ ,  $p<.05$ . Univariate follow-up tests (pairwise t-tests) revealed a trending effect between 1back ( $M=-2.2$ ,  $SD=2.1$ ) and 2 back amplitude ( $M=-1.43$ ,  $SD=1.58$ ),  $t(14)=1.92$ ,  $p=.076$  (Figure 16).

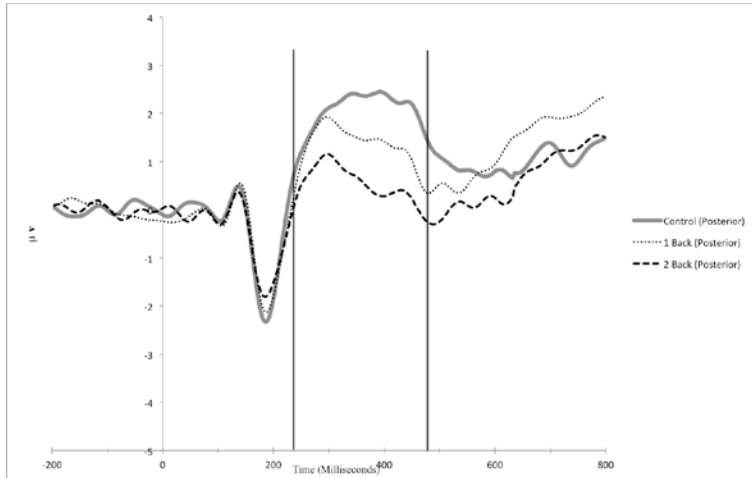

Figure 15

*Posterior Waveform for the N-back Task Indicating P3b Epoch (248-472ms)*

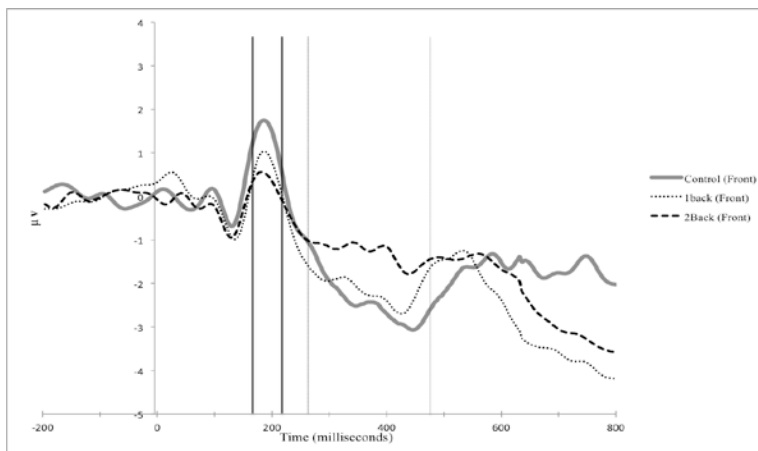

Figure 16

*Frontal Waveform for the N-back Task Indicating 168-208ms and 252-468ms Epochs.*

## **Hypothesis 2 Data Analysis**

*The new executive function tasks will be more correlated with currently used, valid measures of executive function theorized to measure that specific executive component than to other currently used executive tasks. The Control Task will be unrelated to any paper and pencil neuropsychological measure. This will serve to demonstrate convergent and discriminant validity of the new executive measures. Accuracy, Reaction Time, and Reaction Time difference between the control and challenge condition are indicators of performance for the novel tasks.*

Because accuracy was demonstrated to be unhelpful (i.e. scores were at ceiling) when measuring of performance for all tasks except the N-back (updating), accuracy was not used for data analysis of convergent and discriminant validity for any novel task except for the N-back. Reaction time was the primary measure of performance for all novel tasks (Control, Inhibit, Set-shift, and N-back). Reaction time could not be measured for inhibit trials of the Go/No-Go task, as the correct response is “no response” and therefore could not be analyzed under this hypothesis. RT difference between the control and challenge conditions did not provide any additional information than analyzing RT alone, and therefore was also excluded from analysis.

### **Control Task Results**

Control task RT was unrelated to any clinical EF measure (Table 9 & 10).

### **Inhibition Task Results**

*RT's on the tasks of inhibition (Inhibit) will be more strongly correlated with Stroop Test performance as measured by Color-Word scores, than WCST, Trial Making B or LNS. The Inhibit Task RT should be negatively correlated with Stroop Color-Word scores.*

Mean RT of inhibit trials on the Inhibit Task was correlated with total Stroop Color-Word score ( $r(26)=-.431, p<.05$ ). However, with the removal of an outlier, this relationship was no

longer significant, but was reduced to a trend ( $r(25)=-.343, p<.1$ ) (Figure 17) . Mean RT of inhibit trials was not correlated with any other neuropsychological measure (Table 9 &10).

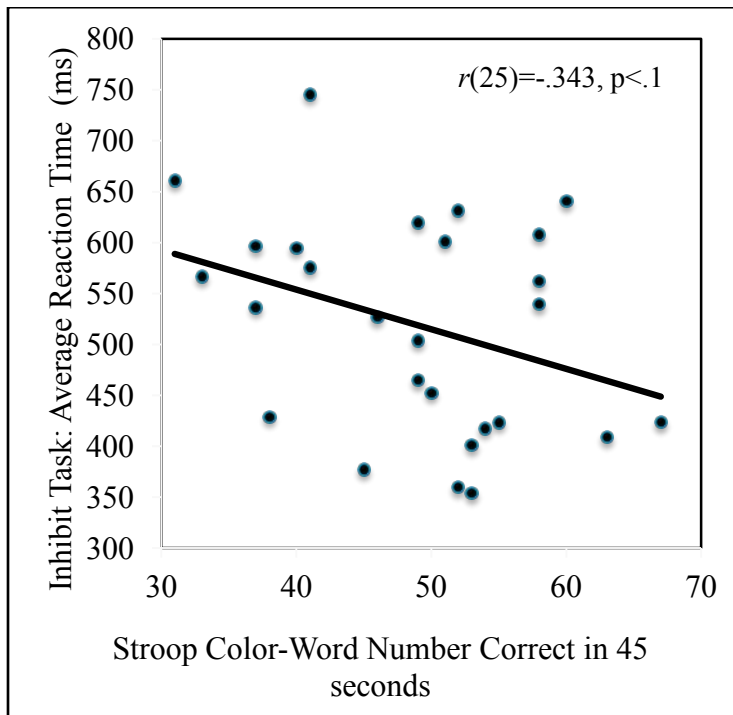

Figure 17

*Relationship between Inhibit Performance (RT) and Stroop Color-Word Raw Scores*

### **Set-Shifting Task Results**

*RTs on the shift trials of the set-shifting task as measured by RT will be more strongly correlated with the Wisconsin Card Sorting Task performance (i.e., measured by number of categories completed, and number of preservative errors) and Trail Making Part B (TMT-B) performance (i.e., time to complete) than stay trials of the set-shifting task. Shift trial RT should be negatively correlated with WSCT scores and positively correlated with TMT-B. Additionally, shift trials should be more strongly correlated with WCST and TMT-B scores than Stroop Color-Word and LNS scores.*

There was no correlation between any condition in the set-shifting task (Shift, Stay, Congruent/Stay, Congruent/Shift, Incongruent/Stay, and Incongruent/Shift) and any performance index of the WSCT. There was a significant correlations with Trail Making Part B (TMT-B) and all set-shift conditions ( $p < .05$ ) (See Table 9), however, these relationships appeared to be driven by a TMT-B outlier (outlier was 4 SD above the grand mean of that task), and all correlations were not significant once the outlier was removed from analysis (See Table 10 & Figure 18). All set-shift conditions were correlated to Stroop Color-Word scores ( $p < .05$ ) (See Table 9). Upon removal of the outlier, the Shift/Incongruent condition remained significantly correlated with Stroop Color-Word scores ( $r(25) = -.398, p < .05$ ), but all other conditions (Congruent/Stay, Congruent/Shift, Incongruent/Stay) were reduced to a trend ( $p < .1$ ) (See Table 10). There were no significant relationships between LNS scores and any condition in the set-shift task. These results suggest inhibition is engaged during the task, though it is questionable whether or not set-shifting is engaged as results became non-significant upon removal of the outlier.

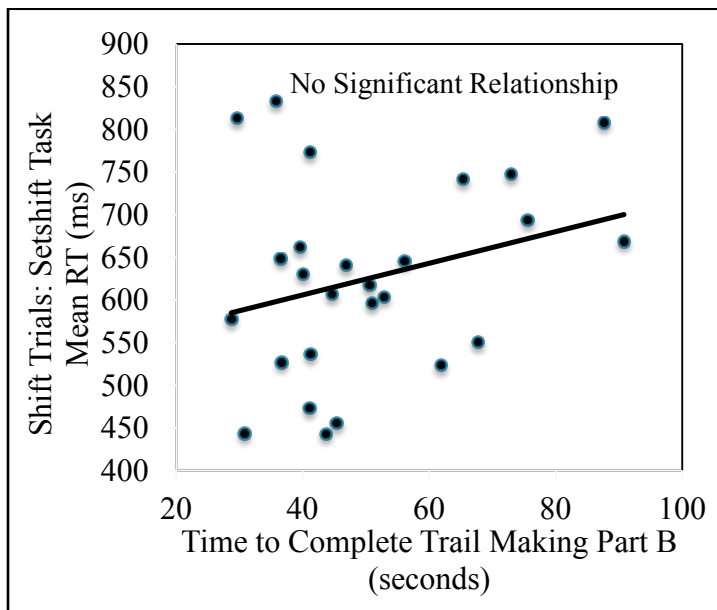

Figure 18

*Relationship between the Shift Condition of the Set-Shifting Task and TMT-B Time to Complete*

## **N-Back Task (Updating) Results**

*RT's on the updating task (N-back) will be more strongly correlated with WAIS-IV Letter-Number Sequencing performance (i.e., measured by longest span remembered (LLNS) and total score (LNS)) than Stroop Color-Word, TMT-B, and WSCT score. N-Back RT should be negatively correlated with LNS performance.*

Total Letter Number Sequencing (LNS) score was associated with the 1-Back condition RT,  $r(25)=-.515, p<.05$  (see Figure 19), 2-Back RT,  $r(25)=-.47, p<.05$ , and 3-Back RT,  $r(25)=-.428, p<.05$ , (Table 9). With outliers removed, both the 2-Back and 3-Back RT relationship was reduced to trending (See Table 9 for results with outliers removed). Longest letter number sequence remembered (LLNS) was associated with the 1-Back RT,  $r(25)=-.421, p<.05$ , 2-Back RT,  $r(25)=-.541, p<.01$ , and was trending with 3-Back,  $r(25)=-.344, p<.1$  (including outliers, Table 9). N-back accuracy for 1, 2 and 3 back conditions were unrelated to performance on the letter-number sequencing task.

Stroop Color-Word was correlated with 1-Back RT  $r(24)=-.503, p<.01$ , 2-Back RT  $r(24)=-.393, p<.05$ , and 3-Back RT  $r(24)=-.44, p<.05$ ) with outliers removed (Table 10). TMT-B time to complete was correlated with 1-Back,  $r(24)=.429, p<.05$  and 3-Back,  $r(24)=.534, p<.01$  performance. The 1-back was most strongly correlated with the Stroop than any other Clinical EF measure and the 3-back was most strongly correlated with TMT-B. 2-Back was most strongly correlated with LLNS. N-Back RT and was unrelated to WSCT performance. These results suggest inhibition and set-shifting may also be engaged during the task.



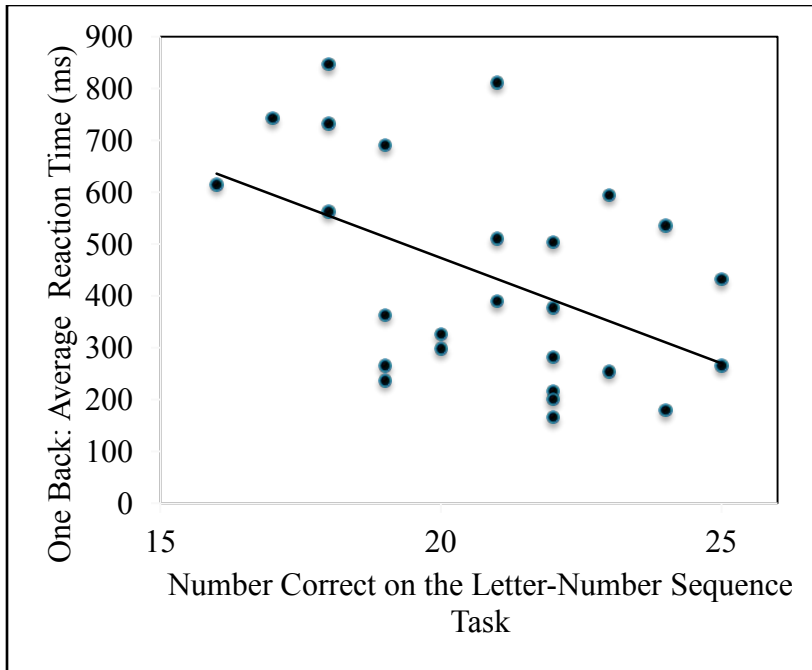

Figure 19  
*Relationship Between Total Letter Number Sequencing Score and 1-Back Reaction Time*

Table 9

*Relationships Between RT on Novel Tasks and Performance on Clinical EF Measures (Outliers Not Removed)*

	Control	Inhibit	Go	1-Back	2-Back	3-Back	Stay/Con	Stay/Incon	Shift/Con	Shift/Incon
TMT-B	NS	NS	NS	.48**	.338 <sup>+</sup>	.492**	.408*	.472*	.398*	.438*
LNS	NS	NS	NS	-.515*	-.47*	-.418*	NS	NS	NS	NS
LLNS	NS	NS	NS	-.421*	-.541**	-.344 <sup>+</sup>	NS	NS	NS	NS
Stroop-CW	NS	-.431*	NS	-.527**	-.488**	-.487**	-.400*	-.439*	-.413*	-.449*
WSCT	NS	NS	NS	NS	NS	NS	NS	NS	NS	NS

\*denotes  $p < .05$ ; \*\*denotes  $p < .01$ ; \*\*\*denotes  $p < .001$ ; <sup>+</sup>denotes  $p < .1$ ; NS denotes Not Significant

-TMT-A & B measured by time to complete; LNS=total correct; LLNS=highest span; Stroop CW= Number Correct; WSCT=All indices (none were correlated with any measure).

Table 10

*Relationships Between RT on Novel Tasks and Performance on Clinical EF Measures with Outliers Removed*

	Control	Inhibit	Go	1-Back	2-Back	3-Back	Stay/Con	Stay/Incon	Shift/Con	Shift/Incon
TMT-B	NS	NS	NS	.429*	NS	.534**	NS	NS	NS	NS
LNS	NS	NS	NS	-.476*	-.363 <sup>+</sup>	-.375 <sup>+</sup>	NS	NS	NS	NS
LLNS	NS	NS	NS	-.397*	-.417*	-.374 <sup>+</sup>	NS	NS	NS	NS
Stroop-CW	NS	-.343 <sup>+</sup>	NS	-.503**	-.393*	-.44*	-.328 <sup>+</sup>	-.368 <sup>+</sup>	-.330 <sup>+</sup>	-.389*
WSCT	NS	NS	NS	NS	NS	NS	NS	NS	NS	NS

\*denotes  $p < .05$ ; \*\*denotes  $p < .01$ ; \*\*\*denotes  $p < .001$ ; <sup>+</sup>denotes  $p < .1$ ; NS denotes Not Significant

-TMT-A & B measured by time to complete; LNS=total correct; LLNS=highest span; Stroop CW= Number Correct; WSCT=All indices (none were correlated with any measure)

## **Chapter Four:**

### **Discussion**

The purpose of this study was to develop a set of executive function measures that can be used in an ERP environment and that address known issues with current neuropsychological measures of executive function. The new measures use simple cognitive operations of inhibition, set-shifting, and updating and use the same stimulus set. This study addressed convergent and discriminate validity for these measures by examining relationships between the novel tasks and currently used neuropsychological measures of executive function (current clinical measures of EF), as well as ERPs theorized to be elicited during inhibition, shifting and updating tasks. The results of the study indicate that the novel executive function tasks may offer a new way of measuring the executive components of inhibition, set-shifting, and updating and provide preliminary evidence of convergent and discriminant validity of these novel tasks. Some of the results from the EEG portion of the study were unexpected. Some predicted differences might have been undetected in this study due to issues with power/ small sample size. Because there were some ERP effects, however, even if they were not in the direction as predicted by the hypotheses, there may be some indication that the differences in the tasks are causing differences in ERP activity.

#### **Control Task**

As expected, the Control task was unrelated to any currently used measure of executive function. Since the other novel tasks all had relationships with current clinical measures of

executive function, the results suggest the Control task is engaging executive processes less than the other tasks.

P3b is theorized to be associated with novelty. One issue with the study's procedure was that the Control task was always administered before any of the other tasks. The rationale behind this was to have participants become comfortable with the tasks and to practice using the response pad. The problem with this approach was that the Control task was novel to the participant at the time, which may have caused larger ERP amplitudes in response to the task, even if participants found it easy. The Control task ERP waveforms were used as a control condition for comparison for the N-back and Inhibit tasks, so the novelty of the Control task may have influenced results. In order to improve upon this, the Control task can be given as practice at the beginning of the procedure, and then given again randomly within the order of the other novel tasks. ERPs from the second administration of the Control task can be used for a control condition and to determine if novelty is a plausible reason for the effects found in the current study. If changing order does not have a change in effect on future results, the development of a more valid Control task may be warranted.

### **Inhibition**

The Inhibit task was only associated with the Stroop Color-Word task, a neuropsychological task of inhibition. This supports the idea that Inhibit task is a task of inhibition and is not engaging updating or set-shifting executive components. Additionally, the Stroop Color-Word task was correlated with all novel task conditions presumed to be associated with executive function and was not associated with the control condition. This supports theories that suggest inhibition may be present in most tasks of executive function, and may not be a separate component like set-shifting or updating. These results are somewhat conflicting,

however, because one would then expect the novel inhibit task to be related to all clinical EF measures if inhibition is a common factor among executive components. Nonetheless, the study still provides some evidence that the Inhibit task may be selectively engaging inhibition processes. There was no difference in ERP waves elicited by the Control task and the Inhibit task. One explanation for the results is though there were no differences in ERP waves, there was a difference in reaction time, with longer reaction times occurring during the inhibit trials compared to control trials, indicating there may be some difference in the tasks, but ERP was not sensitive to these differences. Though the Inhibit task may have taken the brain longer to process the information (as indicated by the reaction time data), the Inhibit task may not have required inhibition of a prepotent response, and therefore did not elicit ERP components typically associated with inhibition. A second explanation is that the combination of the Control task being novel and the Inhibit task becoming less novel over time due to practice caused participants to be less dependent on the inhibition of the prepotent response, which may have contributed to the insignificant results. A third explanation is simply that there were more participants in the Reaction Time analysis than the ERP analysis, so differences between conditions in the ERP analysis may have gone undetected.

The Go/No-Go task could not be evaluated for convergent validity with the clinical EF measures because the No-Go trial correct response is no response. Perhaps comparing the novel Go/No-Go task to a Go/No-Go task previously used in another study may be helpful in providing evidence of convergent validity for this task, as well as improving upon it. In regards to the ERP data, the results for the Go/No-Go task were unexpected because the Go trials had a larger ERP amplitude than the NoGo trials. There are a number of reasons why this may have occurred. In past research, the opposite effect is usually found because No-Go trials require the inhibition of a

prepotent response. Perhaps participants did not inhibit response during the NoGo trials for the novel task, possibly because the task was too easy (participants were 98.7% accurate for Go Trials and 99.91% accurate for No-Go trials). The Go/No-Go task may benefit from modifications such as changing the time interval between stimuli so that it is different throughout the task, which is similar to the Conner's Continuous Performance Test (CPT), a computerized neuropsychological measure typically used to evaluate inhibition. Increasing the time between trials may also make the task more difficult. Another possibility is there were equal number of Go and No-Go trials. One study found that differences in P3 amplitude are eliminated when Go and No-Go trials appear with equal frequency, suggesting that the P3 effect typically found in Go/No-Go studies is novelty driven (Lavric, Pizzagalli, & Forstmeier, 2004). Other studies have shown a larger N2 amplitude when NoGo trials are less frequent than Go trials (Nieuwenhuis, Yeung, Van Den Wildenberg, & Ridderinkhof, 2003). Reducing the proportion of No-Go trials may strengthen the proposed ERP effect.

When visually inspecting the ERP waves for the Go/No-Go task, a waveform resembling the N2-P3 complex is observed, indicating that inhibition may be taking place. This pattern is not observed for the Go trials (the area where the P3 would be expected has a peak pointed in the negative direction, while the No-Go trials have a peak pointing in the positive direction). Perhaps inhibition was occurring for the No-Go condition, but an unexpected effect occurred for the Go trials. The fact there are four different response options may make this Go/No-Go task unique. In typical Go/No-Go task, or even in the CPT, individuals only need to respond to one button and inhibit response to that one button. In the novel task, there are four different responses that participants need to choose from for Go trials, but there is only one correct response (i.e. no

response) for the No-Go trials. This choice for Go trials requires decision making, and decision-making is typically associated with executive function.

There are also theories that suggest the N2 is not related to response inhibition but is related to conflict monitoring, and therefore may be an unhelpful indicator of inhibition for the novel tasks. Perhaps the Go condition in the novel task is eliciting stronger ERP amplitudes than the NoGo condition because of this decision making component of the task, which induces conflict monitoring (Donkers & Van Boxtel, 2004). The Go/No-Go task can also be modified by having individuals respond to just one or two arrows to make the decision making process easier during Go trials and to determine if this changes the relationship between the Go and NoGo conditions. This explanation can also be applied to the Inhibit task, as decision making was required for both Inhibit and Control trials, even if inhibit trials were more difficult, as indexed by slower reaction time on average in response to inhibit trials.

### **Set-Shifting**

The novel set-shifting task was only associated with the Stroop Color-Word task, which was unexpected. Perhaps this task may be stronger as an inhibition type task. Surprisingly, when examining results from the WCST, a task presumed to engage set-shifting, performance was unrelated to any novel measure. Skewness and kurtosis deviated from normal, with most participants performing in the average range, leaving little variation in performance. Perhaps WCST is less sensitive at picking up subtle differences in healthy populations, which may be a reason for non-significant results when examining this measure. Also, the WCST is inherently different from the novel tasks, as time is not factored into performance. Using a task, such as the global-local task as Miyake, Friedman, et al. (2000) described, as a comparison measure may be



more beneficial for examining convergent validity of the novel task because it uses reaction time as a primary means of measuring performance.

Additionally, there was no difference in mean ERP amplitude between shift and stay trials in any epoch analyzed for both frontal and posterior electrodes. Although ERP results were unexpected, behaviorally, shift trials did, however, result in a longer reaction time than stay trials, indicating that there may be some cognitive process that is driving difference in performance between the two conditions. The task may be useful as a set-shift task, with some changes made to the design.

There were several issues identified with this task. The conditions that participants were to switch between were not equally difficult, suggested by the fact participants responded with significantly slower reaction time for incongruent trials than congruent trials, which may have caused inhibition to be the predominant function engaged within the task. Additionally the effect may have been weakened because past research has shown that P3a amplitude is smaller when switching to a less complicated task (Kieffaber & Hetrick, 2005). Furthermore, participants were externally cued when to shift or stay in the novel task, but an internal cue to change sets is required for the WCST and TMT-B. Barceló and colleagues found that P3b activity is not observed when the new rule was cued exogenously (Barceló et al., 2000). Having to internally generate a cue to change sets rather than rely on an external cue may be more dependent on executive function. Also, in set-shift studies, switch costs are bigger when trials are blocked rather than intermixed (Braver et al., 2003; Lenartowicz et al., 2010; Rubin & Meiran, 2005). Perhaps the effect between shift and stay would have been stronger if trials were blocked.

## Updating

The results from this study suggest that the novel N-back task may be a promising updating task. The N-back, the task developed to measure updating (working memory), was the only task related to letter-number sequencing, an already validated working memory task demonstrating both convergent and discriminant validity for the novel task. The N-back task was also correlated with TMT-B and the Stroop task. It is not necessarily surprising that TMT-B was correlated with N-back performance. As discussed, currently used executive function tasks do not purely measure one executive function, and TMT-B is no exception. Research provides evidence that performance on TMT-B depends on working memory (Crowe, 1998; Lezak, 2012) in addition to switching. Similarly, inhibition may also underlie working memory tasks (Roberts Jr & Pennington, 1996). For the N-back task, it was expected that P3b activity would be related to memory load with a U-shaped curve. In this study, P3b activity decreased as memory load increased. These results also correspond with the behavioral data, as accuracy decreased with increased memory load. This may be because the N-back task is really a divided attention task, which may in fact cause a decrease in P3 amplitude as the difficulty of the task increases. One has to remember stimuli presented earlier while paying attention to stimuli being shown on the screen. Watter, Geffen, and Geffen (2001) used an n-back paradigm in their study and also found P300 amplitude decreased as memory load increased. They suggested that n-back tasks could be conceptualized as a dual task, as two distinct tasks are required: a working memory updating subtask and a matching subtask. Results from another study examining differences between spatial and verbal N-back tests found a reduced P3 amplitude as well. They found that P300 amplitude was only affected by memory load, not sensory modality, suggesting that the P300 is involved in higher order functioning (McEvoy, Pellouchoud, Smith, & Gevins, 2001). When

working memory load increases, resource reallocation from response classification and decision making to memory maintenance may be responsible for decreased P300 amplitude (Kok, 2001; McEvoy et al., 2001; McEvoy, Smith, & Gevins, 1998).

The exploratory analysis of the frontal electrodes revealed a positive waveform occurring around 168-208ms, where amplitude of this wave attenuated as memory load increased. There are theories that suggest working memory relies on a network of fronto-parietal connections (Löw et al., 1999; Sauseng, Klimesch, Schabus, & Doppelmayr, 2005). Additional theories suggest the process underlying P300 generation is related to a relay of information from the frontal lobes to temporal-parietal areas. Frontal areas of the brain maintain information in working memory, but when a new stimulus is presented that must be attended to, information about the new stimulus is passed to the temporal-parietal area to enhance memory (Polich, 2007). This is consistent with research suggests that the parietal lobe is involved with holding information in memory and the dorsal lateral prefrontal cortex is involved with the active maintenance of the stored information in the parietal lobe (Haut et al., 2000). Rypma and D'Esposito (1999) suggested that during high memory load tasks, the dorsal lateral prefrontal cortex is recruited for encoding and the ventral lateral prefrontal cortex is involved in the maintenance of information. Perhaps frontal and posterior ERP activity is decreasing as memory load is increasing for the novel N-back task because memory and attention rely on similar cognitive networks (Linden, 2007). Just as P3 amplitude may decrease because of resource reallocation, perhaps this early frontal activity is decreasing because resources are being reallocated from attending to or categorizing the current stimulus to the active maintenance or encoding of memory.

## **Reaction Time Data**

Another result that was helpful to understand task performance was reaction time differences across task conditions. It is expected that more difficult tasks require more time for the brain to process the information, indicating reaction time may be a useful indicator of performance of the tasks. The Inhibit, Go/No-Go, and Set-Shift tasks showed significant differences in reaction time between the executive function and control conditions, indicating that reaction time may be an informative indicator of performance on these tasks. The N-back task may have been more difficult than the other tasks, which may be a reason reaction time was not as informative among task conditions. The difficulty of the N-back influenced accuracy, and therefore, accuracy may be a better indicator of performance across conditions than reaction time for this particular task. N-back RT, however, was related to clinical EF measure performance, indicating that perhaps RT cannot distinguish between N-back conditions, but RT may still be an indicator of performance between high performing and low performing participants. The ability to use behavioral data (RT and accuracy) as indicators of performance is a strength of these tasks as the tasks may be useful to administer, even when EEG acquisition may be unavailable. Additionally, high accuracy among the Control, Inhibit, Go/No-Go and Set-Shift tasks may make the tasks useful as effort measures.

## **Limitations**

This study had a number of limitations. This study had a small sample size ( $N=29$ ) and some true effects may have been unobservable due to low power. Additionally, there were an even smaller number of participants included in the ERP data analysis because of the required 20 clean trials to be included in analysis. This especially may have affected N-back results, since only 15 participants met the clean trial criteria for both 1 back and 2 back conditions. Another

limitation is that participants were college students and the age range was very small (18-26), so these results cannot be generalized to other populations. Additionally, family-wise error corrections were not made for all statistics in this study because of its exploratory nature, so some of the findings may have been due to Type I error (i.e., ERP waves were compared at several time points, which may have increased Type I error rate). The study will need to be conducted again to determine if the same results could be replicated. Furthermore, ERP effects may have been unobservable because the Control Task was always presented first, and the novelty of the task may have impacted ERP activity. Additionally, using paper and pencil neuropsychological tasks (clinical EF measures) may be problematic in themselves to use for a convergent validity study because of the problems with existing executive function tasks, such as task impurity (e.g. there are updating, set-shifting, and inhibition components of the TMT-B task). While the purpose of the novel measure was to engage in simpler components of executive function identified by Miyake and colleagues (2000), there are many areas of executive function that the novel measures do not engage (e.g., cognitive flexibility, generative abilities, planning). Perhaps these executive components can be considered in further development of the novel tasks.

### **Conclusions and Future Directions**

The strength of this project is that it addresses some of the concerns of currently used neuropsychological measures by creating a novel set of measures designed to measure different aspects of executive function. The creation of the tasks was theory driven instead of basing task use on face validity or by adapting tests initially created for other purposes rather than as executive function tasks. The majority of the results, in particular the results of the behavioral data, supported the hypotheses. Some results from this study were not completely expected, mainly some ERP effects, which may be because the tasks are not engaging executive functions

in which they were theorized to engage or ERPs were not sensitive to differences among task conditions.

Further changes based on the results of this study will be made to enhance these tasks. Reducing the number of arrows from four to two may enhance subtle differences between conditions. This is because decision-making processes are required when choosing among the four arrows, which may engage executive processes, even for the Control Task. Additionally, changing proportion of conditions, blocking certain trial types, and varying inter-stimulus intervals between trials may enhance ERP results. Another technique used in ERP research is to impose an accuracy restriction in order to adjust difficulty of the task for each individual. This is achieved by setting a certain percent accuracy (e.g. 80%) and adjusting the inter-stimulus interval to be slower or quicker depending on whether the participant is achieving below or above the designated level of accuracy. In regards to changes to specific tasks, to enhance the effect between shift and stay trials, an internal, rather than external cued set-shift task can be developed. Similar to the WSCT, participants would be required to deduce a rule (such as responding the opposite flashing arrow) in response to feedback given. Once the rule is learned after a number of trials, the rule will change. To strengthen inhibition results, perhaps a task similar to a Stop-Signal Task can be developed.

Future studies should be conducted with improvements to the tasks and repeating the study in a new, larger sample of participants. Furthermore, a larger sample of participants may allow for ERP comparisons between high and low performers across the tasks. Once the tasks are strengthened in a normal population, future studies should also examine the use of these tasks in different populations and to see if similar relationships are found across different populations and whether adjustments may be required for patient populations. Additionally, one can also use

techniques such a Structural Equation Modeling with a large sample size to examine relationships between the novel tasks and latent variables or the executive components they are theorized to engage.

## References

- Arbuthnott, K., & Frank, J. (2000). Executive control in set switching: Residual switch cost and task-set inhibition. *Canadian Journal of Experimental Psychology*, 54(1), 33.
- Aron, A. R. (2007). The neural basis of inhibition in cognitive control. *The Neuroscientist*, 13(3), 214-228.
- Aron, A. R., Monsell, S., Sahakian, B. J., & Robbins, T. W. (2004). A componential analysis of task - switching deficits associated with lesions of left and right frontal cortex. *Brain*, 127(7), 1561-1573.
- Axelrod, B. N., Goldman, R. S., & Woodard, J. L. (1992). Interrater reliability in scoring the Wisconsin card sorting test. *The Clinical Neuropsychologist*, 6(2), 143-155.
- Baddeley, A. (2000). The episodic buffer: a new component of working memory? *Trends in Cognitive Sciences*, 4(11), 417-423.
- Baddeley, A. (2012). Working memory: theories, models, and controversies. *Annual Review of Psychology*, 63, 1-29.
- Baddeley, A. D., & Hitch, G. J. (1974). Working memory. *The Psychology of Learning and Motivation*, 8, 47-89.
- Badre, D., Hoffman, J., Cooney, J. W., & D'Esposito, M. (2009). Hierarchical cognitive control deficits following damage to the human frontal lobe. *Nature Neuroscience*, 12(4), 515-522.
- Banich, M. T. (2009). Executive Function. *Current Directions in Psychological Science*, 18(2), 89.



- Barceló, F. (2003). The Madrid card sorting test (MCST): a task switching paradigm to study executive attention with event-related potentials. *Brain Research Protocols*, 11(1), 27-37.
- Barceló, F., Muñoz-Céspedes, J. M., Pozo, M. A., & Rubia, F. J. (2000). Attentional set shifting modulates the target P3b response in the Wisconsin card sorting test. *Neuropsychologia*, 38(10), 1342-1355.
- Barceló, F., Periáñez, J. A., & Knight, R. T. (2002). Think differently: A brain orienting response to task novelty. *Neuroreport*, 13(15), 1887.
- Barceló, F., Sanz, M., Molina, V., & Rubia, F. J. (1997). The Wisconsin Card Sorting Test and the assessment of frontal function: A validation study with event-related potentials. *Neuropsychologia*, 35(4), 399-408.
- Bekker, E. M., Kenemans, J. L., & Verbaten, M. N. (2005). Source analysis of the N2 in a cued Go/NoGo task. *Cognitive Brain Research*, 22(2), 221-231.
- Berg, E. A. (1948). A simple objective technique for measuring flexibility in thinking. *The Journal of General Psychology*, 39(1), 15-22.
- Beste, C., Saft, C., Gold, R., & Falkenstein, M. (2008). Response inhibition in Huntington's disease--A study using ERPs and sLORETA. *Neuropsychologia*, 46(5), 1290-1297.
- Bledowski, C., Kadosh, K. C., Wibrall, M., Rahm, B., Bittner, R. A., Hoehstetter, K., . . . Linden, D. E. J. (2006). Mental chronometry of working memory retrieval: a combined functional magnetic resonance imaging and event-related potentials approach. *The Journal of Neuroscience*, 26(3), 821-829.
- Bokura, H., Yamaguchi, S., & Kobayashi, S. (2005). Event-related potentials for response inhibition in Parkinson's disease. *Neuropsychologia*, 43(6), 967-975.

- Botvinick, M. M., Braver, T. S., Barch, D. M., Carter, C. S., & Cohen, J. D. (2001). Conflict monitoring and cognitive control. *Psychological Review*, 108(3), 624.
- Botvinick, M. M., Cohen, J. D., & Carter, C. S. (2004). Conflict monitoring and anterior cingulate cortex: an update. *Trends in Cognitive Sciences*, 8(12), 539-546.
- Braver, T. S., Cohen, J. D., Nystrom, L. E., Jonides, J., Smith, E. E., & Noll, D. C. (1997). A parametric study of prefrontal cortex involvement in human working memory. *Neuroimage*, 5(1), 49-62.
- Braver, T. S., Reynolds, J. R., & Donaldson, D. I. (2003). Neural mechanisms of transient and sustained cognitive control during task switching. *Neuron*, 39(4), 713-726.
- Burgess, P. W., Alderman, N., Forbes, C., Costello, A., Coates, L., Dawson, D. R., . . . Channon, S. (2006). The case for the development and use of "ecologically valid" measures of executive function in experimental and clinical neuropsychology. *Journal of the International Neuropsychological Society*, 12(2), 194-209.
- Callicott, J. H., Mattay, V. S., Bertolino, A., Finn, K., Coppola, R., Frank, J. A., . . . Weinberger, D. R. (1999). Physiological characteristics of capacity constraints in working memory as revealed by functional MRI. *Cerebral Cortex*, 9(1), 20-26.
- Chatham, C. H., Claus, E. D., Kim, A., Curran, T., Banich, M. T., & Munakata, Y. (2012). Cognitive Control Reflects Context Monitoring, Not Motoric Stopping, in Response Inhibition. *PLoS One*, 7(2), e31546.
- Chikazoe, J., Jimura, K., Hirose, S., Yamashita, K., Miyashita, Y., & Konishi, S. (2009). Preparation to inhibit a response complements response inhibition during performance of a stop-signal task. *The Journal of Neuroscience*, 29(50), 15870-15877.

- Conway, A. R. A., Kane, M. J., & Engle, R. W. (2003). Working memory capacity and its relation to general intelligence. *Trends in Cognitive Sciences*, 7(12), 547-552.
- Crowe, S. F. (1998). The differential contribution of mental tracking, cognitive flexibility, visual search, and motor speed to performance on parts A and B of the Trail Making Test. *Journal of Clinical Psychology*, 54(5), 585-591.
- Crowe, S. F. (2000). Does the letter number sequencing task measure anything more than digit span? *Assessment*, 7(2), 113-117.
- Donchin, E. (1981). Presidential address, 1980. Surprise!... Surprise? *Psychophysiology*, 18(5), 493.
- Donchin, E., & Coles, M. G. (1988). Is the P300 component a manifestation of context updating? *Behavioral and Brain Sciences*, 11, 357-374.
- Donchin, E., Kramer, A., & Wickens, C. (1986). Applications of brain event-related potentials to problems in engineering psychology. *Psychophysiology: Systems, Processes, and Applications*, 702-718.
- Donkers, F. C. L., & Van Boxtel, G. J. M. (2004). The N2 in go/no-go tasks reflects conflict monitoring not response inhibition. *Brain and Cognition*, 56(2), 165-176.
- Eimer, M. (1993). Effects of attention and stimulus probability on ERPs in a Go/Nogo task. *Biological Psychology*, 35(2), 123-138.
- Enriquez-Geppert, S., Konrad, C., Pantev, C., & Huster, R. J. (2010). Conflict and inhibition differentially affect the N200/P300 complex in a combined go/nogo and stop-signal task. *Neuroimage*, 51(2), 877-887.
- Falkenstein, M., Hoormann, J., & Hohnsbein, J. (1999). ERP components in Go/Nogo tasks and their relation to inhibition. *Acta Psychologica*, 101(2-3), 267-291.

- Falkenstein, M., Hoormann, J., & Hohnsbein, J. (2002). Inhibition-related ERP components: Variation with modality, age, and time-on-task. *Journal of Psychophysiology, 16*(3), 167.
- Fals-Stewart. (1991). An interrater reliability study of the Trail Making Test (Part A and B). *Unpublished manuscript.*
- Fals-Stewart, W. (1992). An interrater reliability study of the Trail Making Test (Parts A and B). *Perceptual and Motor Skills, 74*(1), 39-42.
- Field, A. (2005). *Discovering Statistics Using SPSS, 2nd Edition*: SAGE Publications.
- Fisk, J. E., & Sharp, C. A. (2004). Age-related impairment in executive functioning: Updating, inhibition, shifting, and access. *Journal of Clinical and Experimental Neuropsychology, 26*(7), 874-890.
- Floden, D., & Stuss, D. T. (2006). Inhibitory control is slowed in patients with right superior medial frontal damage. *Journal of Cognitive Neuroscience, 18*(11), 1843-1849.
- Folstein, J. R., & Van Petten, C. (2008). Influence of cognitive control and mismatch on the N2 component of the ERP: a review. *Psychophysiology, 45*(1), 152-170.
- Friedman, D., Cycowicz, Y. M., & Gaeta, H. (2001). The novelty P3: an event-related brain potential (ERP) sign of the brain's evaluation of novelty. *Neuroscience and Biobehavioral Reviews, 25*(4), 355-373.
- Friedman, D., Nessler, D., Johnson Jr, R., Ritter, W., & Bersick, M. (2007). Age-related changes in executive function: an event-related potential (ERP) investigation of task-switching. *Aging, Neuropsychology, and Cognition, 15*(1), 95-128.
- Friedman, N. P., & Miyake, A. (2004). The relations among inhibition and interference control functions: a latent-variable analysis. *Journal of Experimental Psychology: General, 133*(1), 101.

- Friedman, N. P., Miyake, A., Corley, R. P., Young, S. E., DeFries, J. C., & Hewitt, J. K. (2006). Not all executive functions are related to intelligence. *Psychological Science, 17*(2), 172.
- Friedman, N. P., Miyake, A., Young, S. E., DeFries, J. C., Corley, R. P., & Hewitt, J. K. (2008). Individual differences in executive functions are almost entirely genetic in origin. *Journal of Experimental Psychology: General, 137*(2), 201.
- Gilbert, S. J., & Burgess, P. W. (2008). Executive function. *Current Biology, 18*(3), 110.
- Golden, C., & Freshwater, S. (1978). Stroop Color and Word Test: A manual for clinical and experimental use. *Wood Dale, Illinois: Stoelting Company.*
- Golden, C. J. (1978). *Stroop Color and Word Test: Cat. No. 30150M; a Manual for Clinical and Experimental Uses*: Stoelting.
- Grant, D. A., & Berg, E. (1948). A behavioral analysis of degree of reinforcement and ease of shifting to new responses in a Weigl-type card-sorting problem. *Journal of Experimental Psychology, 38*(4), 404.
- Greve, K. W. (1993). Can perseverative responses on the Wisconsin Card Sorting Test be scored accurately? *Archives of Clinical Neuropsychology, 8*(6), 511-517.
- Greve, K. W., Stickle, T. R., Love, J. M., Bianchini, K. J., & Stanford, M. S. (2005). Latent structure of the Wisconsin Card Sorting Test: a confirmatory factor analytic study. *Archives of Clinical Neuropsychology, 20*(3), 355-364.
- Gruendler, T. O. J., Ullsperger, M., & Huster, R. J. (2011). Event-Related Potential Correlates of Performance-Monitoring in a Lateralized Time-Estimation Task. *PLoS One, 6*(10), e25591.
- Handy, T. C. (2004). *Event-related potentials: A methods handbook*: MIT press.

- Haut, M. W., Kuwabara, H., Leach, S., & Arias, R. G. (2000). Neural activation during performance of number-letter sequencing. *Applied Neuropsychology*, 7(4), 237-242.
- Hedden, T., & Gabrieli, J. D. E. (2010). Shared and selective neural correlates of inhibition, facilitation, and shifting processes during executive control. *Neuroimage*, 51(1), 421-431.
- Hughes, G., Velmans, M., & De Fockert, J. (2009). Unconscious priming of a no - go response. *Psychophysiology*, 46(6), 1258-1269.
- Jersild, A. T. (1927). Mental set and shift. *Archives of Psychology; Archives of Psychology*.
- Jodo, E., & Kayama, Y. (1992). Relation of a negative ERP component to response inhibition in a Go/No-go task. *Electroencephalography and Clinical Neurophysiology*, 82(6), 477-482.
- Kane, M. J., Bleckley, M. K., Conway, A. R. A., & Engle, R. W. (2001). A controlled-attention view of working-memory capacity. *Journal of Experimental Psychology: General*, 130(2), 169.
- Kane, M. J., & Engle, R. W. (2003). Working-memory capacity and the control of attention: the contributions of goal neglect, response competition, and task set to Stroop interference. *Journal of Experimental Psychology*, 132(1), 47.
- Kieffaber, P. D., & Hetrick, W. P. (2005). Event - related potential correlates of task switching and switch costs. *Psychophysiology*, 42(1), 56-71.
- Kok, A. (2001). On the utility of P3 amplitude as a measure of processing capacity. *Psychophysiology*, 38(3), 557-577.
- Larson, M. J., & Clayson, P. E. (2011). The relationship between cognitive performance and electrophysiological indices of performance monitoring. *Cognitive, Affective, & Behavioral Neuroscience*, 11(2), 159-171.

- Lavric, A., Mizon, G. A., & Monsell, S. (2008). Neurophysiological signature of effective anticipatory task - set control: a task - switching investigation. *European Journal of Neuroscience*, 28(5), 1016-1029.
- Lavric, A., Pizzagalli, D. A., & Forstmeier, S. (2004). When 'go' and 'nogo' are equally frequent: ERP components and cortical tomography. *European Journal of Neuroscience*, 20(9), 2483-2488.
- Leh, S. E., Petrides, M., & Strafella, A. P. (2009). The neural circuitry of executive functions in healthy subjects and Parkinson's disease. *Neuropsychopharmacology*, 35(1), 70-85.
- Lenartowicz, A., Escobedo-Quiroz, R., & Cohen, J. D. (2010). Updating of context in working memory: an event-related potential study. *Cognitive, Affective, & Behavioral Neuroscience*, 10(2), 298-315.
- Lezak, M. D., Howieson, D., Bigler, E., & Tranel, D. (2012). *Neuropsychological Assessment* (5 ed.). New York: Oxford University Press.
- Lichtenberger, E. O., & Kaufman, A. S. (2009). *Essentials of WAIS-IV assessment* (Vol. 50): John Wiley & Sons Inc.
- Linden, D. E. J. (2007). The working memory networks of the human brain. *The Neuroscientist*, 13(3), 257-267.
- Löw, A., Rockstroh, B., Cohen, R., Hauk, O., Berg, P., & Maier, W. (1999). Determining working memory from ERP topography. *Brain Topography*, 12(1), 39-47.
- Masterman, D. L., & Cummings, J. L. (1997). Frontal-subcortical circuits: the anatomic basis of executive, social and motivated behaviors. *Journal of Psychopharmacology*, 11(2), 107-114.

- McEvoy, L. K., Pellouchoud, E., Smith, M. E., & Gevins, A. (2001). Neurophysiological signals of working memory in normal aging. *Cognitive Brain Research*, *11*(3), 363-376.
- McEvoy, L. K., Smith, M. E., & Gevins, A. (1998). Dynamic cortical networks of verbal and spatial working memory: effects of memory load and task practice. *Cerebral Cortex*, *8*(7), 563-574.
- McNab, F., Leroux, G., Strand, F., Thorell, L., Bergman, S., & Klingberg, T. (2008). Common and unique components of inhibition and working memory: an fMRI, within-subjects investigation. *Neuropsychologia*, *46*(11), 2668.
- Mega, M. S., & Cummings, J. L. (1994). Frontal-subcortical circuits and neuropsychiatric disorders. *Journal of Neuropsychiatry and Clinical Neurosciences*, *6*(4), 358.
- Menon, V., Adleman, N., White, C., Glover, G., & Reiss, A. (2001). Error - related brain activation during a Go/NoGo response inhibition task. *Human Brain Mapping*, *12*(3), 131-143.
- Miller, E. K., & Cohen, J. D. (2001). An integrative theory of prefrontal cortex function. *Annual Review of Neuroscience*, *24*(1), 167-202.
- Miller, E. K., & Wallis, J. D. (2009). Executive function and higher-order cognition: Definition and neural substrates. *Encyclopedia of Neuroscience*, *4*, 99-104.
- Miyake, A., Emerson, M. J., & Friedman, N. P. (2000). Assessment of executive functions in clinical settings: Problems and recommendations. *Seminars in Speech and Language*, *21*(2), 169-183.
- Miyake, A., & Friedman, N. P. (2012). The Nature and Organization of Individual Differences in Executive Functions Four General Conclusions. *Current Directions in Psychological Science*, *21*(1), 8-14.



- Miyake, A., Friedman, N. P., Emerson, M. J., Witzki, A. H., Howerter, A., & Wager, T. D. (2000). The unity and diversity of executive functions and their contributions to complex "frontal lobe" tasks: a latent variable analysis. *Cognitive Psychology*, 41(1), 49-100.
- Monsell, S. (2003). Task switching. *Trends in Cognitive Sciences*, 7(3), 134-140.
- Morgan, H. M., Klein, C., Boehm, S. G., Shapiro, K. L., & Linden, D. E. J. (2008). Working memory load for faces modulates P300, N170, and N250r. *Journal of Cognitive Neuroscience*, 20(6), 989-1002.
- Mostofsky, S. H., & Simmonds, D. J. (2008). Response inhibition and response selection: two sides of the same coin. *Journal of Cognitive Neuroscience*, 20(5), 751-761.
- Nakao, Y., Kodabashi, A., Yarita, M., Fujimoto, T., & Tamura, T. (2012). *Temporal activities during P3 components on the working memory-related brain regions: N-back ERP study*. Paper presented at the Biomedical and Health Informatics (BHI), 2012 IEEE-EMBS International Conference on.
- Nieuwenhuis, S., Yeung, N., Van Den Wildenberg, W., & Ridderinkhof, K. R. (2003). Electrophysiological correlates of anterior cingulate function in a go/no-go task: effects of response conflict and trial type frequency. *Cognitive, Affective, & Behavioral Neuroscience*, 3(1), 17-26.
- Periáñez, J. A., Maestú, F., Barceló, F., Fernández, A., Amo, C., & Ortiz Alonso, T. (2004). Spatiotemporal brain dynamics during preparatory set shifting: MEG evidence. *Neuroimage*, 21(2), 687-695.
- Picton, T. W., Stuss, D. T., Alexander, M. P., Shallice, T., Binns, M. A., & Gillingham, S. (2007). Effects of focal frontal lesions on response inhibition. *Cerebral Cortex*, 17(4), 826-838.

- Polich, J. (1998). P300 clinical utility and control of variability. *Journal of Clinical Neurophysiology*, 15(1), 14.
- Polich, J. (2003). Theoretical overview of P3a and P3b. *Detection of change: Event-related potential and fMRI findings*, 83-98.
- Polich, J. (2007). Updating P300: an integrative theory of P3a and P3b. *Clinical Neurophysiology*, 118(10), 2128-2148.
- Rabin, L. A., Barr, W. B., & Burton, L. A. (2005). Assessment practices of clinical neuropsychologists in the United States and Canada: A survey of INS, NAN, and APA Division 40 members. *Archives of Clinical Neuropsychology*, 20(1), 33-65.
- Redick, T. S., Calvo, A., Gay, C. E., & Engle, R. W. (2011). Working memory capacity and go/no-go task performance: Selective effects of updating, maintenance, and inhibition. *Journal of Experimental Psychology: Learning, Memory, and Cognition*, 37(2), 308.
- Reitan, R. M. (1958). Validity of the Trail Making Test as an indicator of organic brain damage. *Perceptual and Motor Skills*, 8(3), 271-276.
- Reitan, R. M., & Wolfson, D. (1985). *The Halstead-Reitan neuropsychological test battery: Theory and clinical interpretation*: Neuropsychology Press Tucson, AZ.
- Roberts Jr, R. J., & Pennington, B. F. (1996). An interactive framework for examining prefrontal cognitive processes. *Developmental Neuropsychology*, 12(1), 105-126.
- Roche, R. A. P., Garavan, H., Foxe, J. J., & O'Mara, S. M. (2005). Individual differences discriminate event-related potentials but not performance during response inhibition. *Experimental Brain Research*, 160(1), 60-70.

- Rubin, O., & Meiran, N. (2005). On the origins of the task mixing cost in the cuing task-switching paradigm. *Journal of Experimental Psychology: Learning, Memory, and Cognition*; 31(6), 1477.
- Rypma, B., & D'Esposito, M. (1999). The roles of prefrontal brain regions in components of working memory: effects of memory load and individual differences. *Proceedings of the National Academy of Sciences*, 96(11), 6558-6563.
- Salthouse, T. A. (2005). Relations between cognitive abilities and measures of executive functioning. *Neuropsychology*, 19(4), 532.
- Sattler, J. M., Sattler, J. M., & Ryan, J. J. (2009). *Assessment with the WAIS-IV*: Jerome M Sattler Publisher.
- Sauseng, P., Klimesch, W., Schabus, M., & Doppelmayr, M. (2005). Fronto-parietal EEG coherence in theta and upper alpha reflect central executive functions of working memory. *International Journal of Psychophysiology*, 57(2), 97-103.
- Smith, J. L., Johnstone, S. J., & Barry, R. J. (2008). Movement-related potentials in the Go/NoGo task: The P3 reflects both cognitive and motor inhibition. *Clinical neurophysiology*, 119(3), 704-714.
- Spector, A., & Biederman, I. (1976). Mental set and mental shift revisited. *The American Journal of Psychology*, 669-679.
- St Clair-Thompson, H. L., & Gathercole, S. E. (2006). Executive functions and achievements in school: Shifting, updating, inhibition, and working memory. *The Quarterly Journal of Experimental Psychology*, 59(4), 745-759.
- Sternberg, S. (1969). Memory-scanning: Mental processes revealed by reaction-time experiments. *American scientist*, 57(4), 421-457.

- Strauss, E., Sherman, E. M. S., & Spreen, O. (2006). *A compendium of neuropsychological tests: Administration, norms, and commentary*: Oxford University Press, USA.
- Stuss, D. T. (2007). New approaches to prefrontal lobe testing. *The Human Frontal Lobes: Functions and disorders*, 2, 292-305.
- Stuss, D. T. (2011). Functions of the frontal lobes: Relation to executive functions. *Journal of the International Neuropsychological Society*, 17(5), 759-765.
- Stuss, D. T., Bisschop, S. M., Alexander, M. P., Levine, B., Katz, D., & Izukawa, D. (2001). The trail making test: A study in focal lesion patients. *Psychological Assessment*, 13(2), 230-239.
- Suchy, Y. (2009). Executive functioning: Overview, assessment, and research issues for non-neuropsychologists. *Annals of Behavioral Medicine*, 37(2), 106-116.
- Swick, D., Ashley, V., & Turken, A. U. (2008). Left inferior frontal gyrus is critical for response inhibition. *BMC Neuroscience*, 9(1), 102.
- Sylvester, C. Y. C., Wager, T. D., Lacey, S. C., Hernandez, L., Nichols, T. E., Smith, E. E., & Jonides, J. (2003). Switching attention and resolving interference: fMRI measures of executive functions. *Neuropsychologia*, 41(3), 357-370.
- Testa, R., Bennett, P., & Ponsford, J. (2012). Factor Analysis of Nineteen Executive Function Tests in a Healthy Adult Population. *Archives of Clinical Neuropsychology*, 27(2), 213-224.
- van Gaal, S., Lamme, V. A. F., Fahrenfort, J. J., & Ridderinkhof, K. R. (2011). Dissociable brain mechanisms underlying the conscious and unconscious control of behavior. *Journal of Cognitive Neuroscience*, 23(1), 91-105.

- van Gaal, S., Ridderinkhof, K. R., van den Wildenberg, W. P. M., & Lamme, V. A. F. (2009). Dissociating consciousness from inhibitory control: evidence for unconsciously triggered response inhibition in the stop-signal task. *Journal of Experimental Psychology: Human Perception and Performance*, 35(4), 1129-1139.
- Vandierendonck, A., Liefvooghe, B., & Verbruggen, F. (2010). Task switching: interplay of reconfiguration and interference control. *Psychological Bulletin*, 136(4), 601-626.
- Verbruggen, F., & Logan, G. D. (2009). Automaticity of cognitive control: Goal priming in response-inhibition paradigms. *Journal of Experimental Psychology: Learning, Memory, and Cognition*, 35(5), 1381-1388.
- Wager, T. D., & Smith, E. E. (2003). Neuroimaging studies of working memory. *Cognitive, Affective, & Behavioral Neuroscience*, 3(4), 255-274.
- Watter, S., Geffen, G. M., & Geffen, L. B. (2001). The n - back as a dual - task: P300 morphology under divided attention. *Psychophysiology*, 38(6), 998-1003.
- Weissman, D. H., Giesbrecht, B., Song, A. W., Mangun, G. R., & Woldorff, M. G. (2003). Conflict monitoring in the human anterior cingulate cortex during selective attention to global and local object features. *Neuroimage*, 19(4), 1361-1368.
- Weissman, D. H., Gopalakrishnan, A., Hazlett, C., & Woldorff, M. (2005). Dorsal anterior cingulate cortex resolves conflict from distracting stimuli by boosting attention toward relevant events. *Cerebral Cortex*, 15(2), 229-237.
- West, R., & Moore, K. (2005). Adjustments of cognitive control in younger and older adults. *Cortex*, 41(4), 570-581.

## **Appendix A**

### **Test Development and Piloting**

Tasks were created to engage in the executive components of set-shifting, updating, and inhibition proposed by Miyake and colleagues. Some tasks, such as the N-back and the Go/No-Go tasks were based off of already existing executive function tasks that are used in ERP environments. Tasks were developed to all use the same stimulus set. Tasks were discussed and developed throughout in several lab meetings with Dr. Potts and Dr. Cimino. Eight tasks were conceptualized (one control task, three updating tasks (two versions of the N-back), two set-shifting tasks, and two inhibition tasks). Once tasks were conceptualized, they were programmed using E-Prime 2.0.

#### **Round 1**

Three participants (two female, ages 25-26) were given seven tasks (one control, two updating (one version of the N-back), two set-shifting, two inhibition) in a randomized order, with the control task always being the first task. They were given a questionnaire about the quality of the tasks (see Appendix B). For each task, participants were asked to rate the clarity of the directions and how could the directions be made clearer. They were asked to rate the difficulty of the tasks and if they thought a practice trial would be helpful. They also had to provide suggestions on how the tasks could be improved. After this round of piloting, trial time was increased, directions were clarified, arrow stimuli were changed from white to black, a countdown before the start of the task was added, and a practice trial was added. Additional changes were made to eliminate any discrepancies before piloting round 2. Data from this round

was not analyzed, as the purpose of this piloting session was to increase the quality of the tasks. The internal cue set-shifting task was eliminated as it seemed to be an impure measure of executive function as it required all three executive components (updating was required to remember what was done the trial before) and participants had trouble with the task. The memory buffer task was eliminated as well as more trials would have to be added, which would have greatly increased the time the study would take.

## Round 2

Five participants (four female, ages 23-28) were given five tasks (two inhibition, one updating, one set-shifting, and control) in a randomized order, with the control task always being administered task. The first three participants were also given the same quality control questionnaire as the round 1 piloting participants. Total time to complete the tasks was recorded. Total completion of all 5 tasks takes between 30-40 minutes. Data was analyzed from this round of piloting. The following tables (11 & 12) report the accuracy frequencies and mean reaction time data for the tasks across all subjects. All conditions in all tasks consisted of 40 trials.

Table 11  
*Mean Reaction Time and Pooled Accuracy for All Subjects.*

<i>Task</i>	<i>Mean Reaction Time (ms)</i>	<i>Pooled Accuracy</i>
Control	383.16 (94.81)	190/200
Inhibit	519.71 (112.42)	195/200
Go/No-Go:		
Go Trials	509.18 (106.3)	200/200
No-Go Trials	N/A	200/200
Set-Shifting:		
Congruent Trials	613.64 (120.09)	190/200
Incongruent Trials	669.46 (161.87)	193/200
N-Back:		
1-Back	513.82 (371.87)	187/200
2-Back	493.78 (490.47)	103/200
3-Back	411.12 (381.98)	68/200

Table 12

*Accuracy and Mean Reaction Time (ms) for Each Participant.*

<b>Subject</b>	<b>Control</b>	<b>Inhibit</b>	<b>SS Cong</b>	<b>SS Incon</b>	<b>Go</b>	<b>1-back</b>	<b>2-back</b>	<b>3-back</b>
<b>004</b>								
ACC	<b>38/40</b>	<b>39/40</b>	<b>36/40</b>	<b>40/40</b>	<b>40/40</b>	<b>40/40</b>	<b>28/40</b>	<b>10/40</b>
RT	371.13	571.4	654.95	667.6	543.23	578.13	694.5	548.38
SD	(72.27)	(157.35)	(102.65)	(119.39)	(130.65)	(283.43)	(476.25)	(211.42)
<b>005</b>								
ACC	<b>40/40</b>	<b>37/40</b>	<b>37/40</b>	<b>38/40</b>	<b>40/40</b>	<b>40/40</b>	<b>8/40</b>	<b>8/40</b>
RT	421.35	538.4	557.47	596.43	491.98	402.92	378.1	718.42
SD	(134.61)	(91.03)	(137.31)	(142.2)	(69.86)	(103.84)	(501.71)	(573.17)
<b>006</b>								
ACC	<b>33/40</b>	<b>40/40</b>	<b>39/40</b>	<b>39/40</b>	<b>40/40</b>	<b>40/40</b>	<b>14/40</b>	<b>24/40</b>
RT	363.48	521.93	630.68	692.23	477.35	297.26	439.65	258.62
SD	(89.39)	(87.06)	(81.12)	(115.19)	(70.1)	(115.55)	(405.02)	(156.59)
<b>007</b>								
ACC	<b>40/40</b>	<b>40/40</b>	<b>39/40</b>	<b>39/40</b>	<b>40/40</b>	<b>39/40</b>	<b>38/40</b>	<b>16/40</b>
RT	373.18	463.03	579.9	619.88	521.75	257.38	225.35	191.53
SD	(79.53)	(84.24)	(105.87)	(97.06)	(126.43)	(70.08)	(80.03)	(130.23)
<b>008</b>								
ACC	<b>39/40</b>	<b>39/40</b>	<b>39/40</b>	<b>37/40</b>	<b>40/40</b>	<b>28/40</b>	<b>15/40</b>	<b>10/40</b>
RT	386.65	503.8	644.38	773.79	511.58	1182.03	681.93	352.41
SD	(77.81)	(100.55)	(137.61)	(240.68)	(110.06)	(317.87)	(640.78)	(379.32)

### Pilot Round 2 Results

Reaction time is one way of indexing task difficulty, with the expectation that tasks that are more difficult will be associated with longer response times because the brain takes a longer time to process information (Sternberg, 1969). Because differences in reaction time is an indicator of a cognitive operation at work (Burgess et al., 2006), and there are certain expectations about difficulty differences between certain conditions, reaction time was used to determine if tasks were working as expected, with conditions engaging in executive function being associated with longer response time. Reaction time may be a more accurate measure to examine differences between conditions because accuracy is high across conditions. A multivariate repeated measures analysis was unable to be conducted because of the small sample



size and large number of dependent variables, but paired-sample t-tests were used to examine differences between conditions thought to be engaging executive function and control conditions. All analyses used task condition as the independent variable and reaction time in milliseconds as the dependent variable. **Inhibition:** There was a significant difference between the and Inhibit ( $M=508.34$ ,  $SD=32.4$ ) and Control trials ( $M=374.04$ ,  $SD=24.93$ ),  $t(4)= 8.49$ ,  $p<0.01$ . There was a significant difference between the Control ( $M=374.04$ ,  $SD=24.93$ ) and Go trials of the Go/No-Go task ( $M=500.73$ ,  $SD=27.12$ ),  $t(4)=7.24$ ,  $p<0.01$ . **Set-Shifting:** There was no significant difference between Shift ( $M=626.7$   $SD=44.66$ ) and Non-Shift trials ( $M=612.86$ ,  $SD=42.22$ ),  $t(4)=.949$ ,  $p=0.106$ . There was a significant difference between Congruent ( $M=603.04$ ,  $SD=41.77$ ) and Incongruent ( $M=646.3$   $SD=52.34$ ) trials of the set-shift task  $t(4)=4.02$ ,  $p<.05$ . **Updating:** There was no significant difference of condition on reaction time among any of the conditions of 1 back ( $M=534.53$ ,  $SD=379.1$ ), 2 back ( $M=705.86$ ,  $SD=363.46$ ), and 3 back ( $M=474.63$ ,  $SD=474.63$ ). With the removal of an outlier (subject 008), differences between 0-3 back were not significant. Because accuracy was not at ceiling for the N-back task, accuracy may be a more accurate measure of effect of memory load on test performance than reaction time. A repeated measures ANOVA comparing the accuracy of the 3 N-back conditions and the control task was computed to assess if memory load affected accuracy. The assumption of sphericity was met ( $p=.849$ ). There was a significant difference of effect of condition on accuracy in the N-Back task  $F(2, 12)=14.114$ ,  $p<0.001$ . Post-hoc analysis using paired sample t-tests revealed a significant difference between the 1 back and 2 back  $t(4)=3.06$ ,  $p<.05$ , 1 back and 3 back  $t(4)= 7.51$ ,  $p<0.01$ , and the Control task and 3 back  $t(4)=6.01$ ,  $p<.01$ .

### Round 3

Three participants (2 female, ages 27-29) were given the set-shift task to determine if there was an effect between shift and non-shift trials after changing the task to have equal number of shift and non-shift trials. The difference between shift ( $M=802.83$ ,  $SD=126.16$ ) and non-shift ( $M=729.72$ ,  $SD=115.21$ ) was approaching significance  $t(2)=3.96$ ,  $p=.058$ .



## Appendix C

### Novel Task Descriptions

\*Note: Inter-trial interval (ITI) is set to 1750ms for each task. All tasks begin with a practice trial that the experimenter observes in order to ensure the participant understands the task.

The experimenter reads the instructions to the participant. Additionally, each task begins with a countdown once the participant presses the spacebar to begin the task.

**Control Task (Figure 20):** Participants are shown four arrows on the screen. One of the arrows flash randomly and participant must press the corresponding response button. *Instructions:* In this experiment, you will see an image of four arrows on the screen. The directions of the arrows are up, down, left and right. When an arrow flashes, press the corresponding arrow on the number keypad. The 8 key is up, the 2 key is down, the 4 key is left, and the 6 key is right. Respond as quickly and accurately as possible. Any Questions?

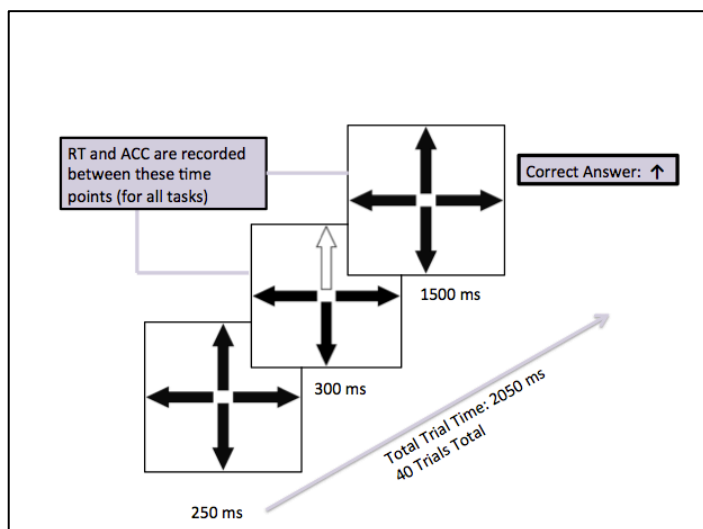

Figure 20. Control Task

## Inhibition

**Inhibition Task 1 (Inhibit) (Figure 21):** Participants must press the arrow in the opposite direction of where the highlighted arrow is pointing (correct response is incongruent arrow).

*Instructions:* In this experiment, you will see an image of four arrows on the screen. The directions of the arrows are up, down, left and right. For every trial, press the opposite arrow on the number keypad than the arrow that flashes. The 8 key is up, the 2 key is down, the 4 key is left, and the 6 key is right. Respond as quickly and accurately as possible. Any Questions?

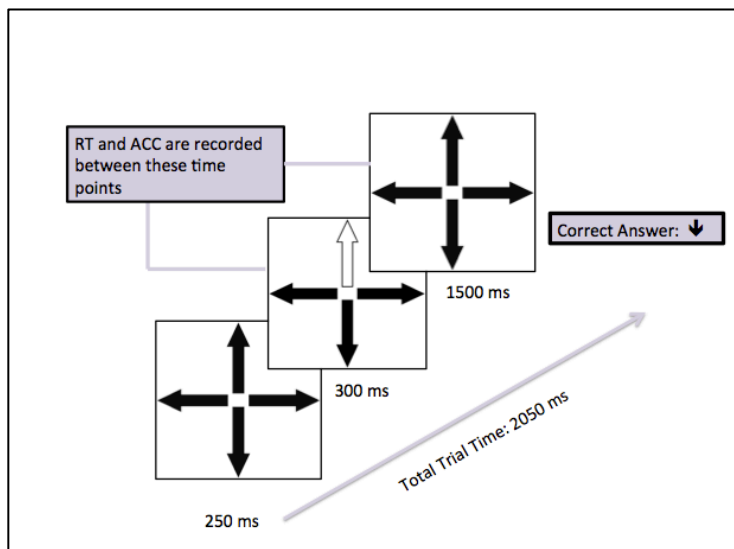

Figure 21. *Inhibit Task*

## **Inhibition Task 2 (Go/No-Go) (Figure 22)**

This inhibition task is a modified go/no-go task. Participants must respond to one stimulus and must inhibit response for the other. Arrows will randomly change either green or red for each trial. When the arrow is green, participants will have to respond to the corresponding arrow (correct response is the corresponding arrow that was flashed during the trial). When the arrow is red, participants will have to inhibit response (correct response on these trials will be 'no response').

*Instructions:* In this experiment, you will see an image of four arrows on the screen. The directions of the arrows are up, down, left and right. Arrows will flash either green or red. When an arrow flashes, green, press the corresponding arrow on the number keypad. When an arrow flashes red, do not respond (do not press a button). The 8 key is up, the 2 key is down, the 4 key is left, and the 6 key is right. Respond as quickly and accurately as possible. Any Questions?

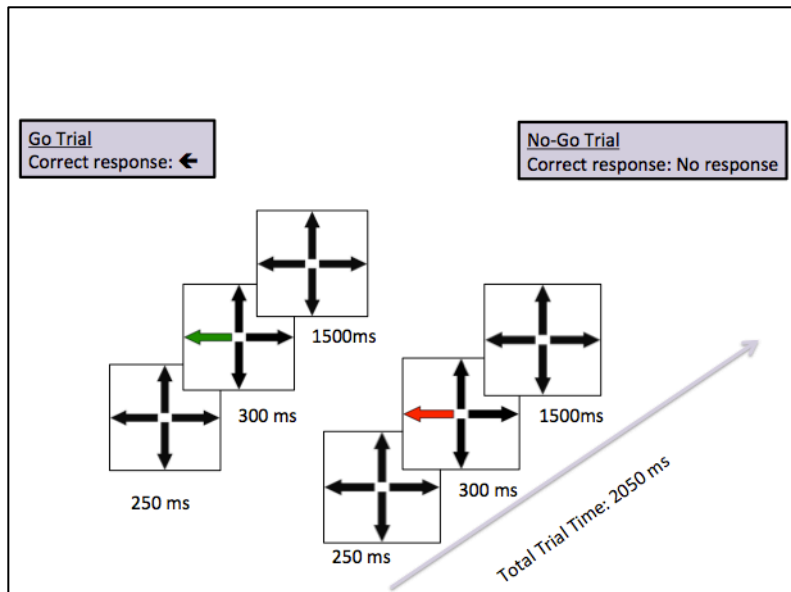

Figure 22. *Go/No-Go Task*

**Set-Shifting (Figure 23):** This task encompasses switching and inhibition with an external cue to shift sets. Participants are shown the same stimuli as the control condition. On each trial, one of the four arrows randomly flashes either green or red. When the stimulus is green, participants are to respond with the corresponding response button (correct response for congruent trials). When the stimulus is red, participants are to respond with the opposite response button (correct response for incongruent trials) (switch + inhibit). *Instructions:* In this experiment, you will see an image of four arrows on the screen. The directions of the arrows are up, down, left and right. Arrows will flash either green or red. When an arrow flashes green, press the corresponding arrow on the keypad. When an arrow flashes, red, press the opposite arrow on the keypad. The 8

key is up, the 2 key is down, the 4 key is left, and the 6 key is right. Opposite Keys: Left & Right; Up & Down. Respond as quickly and accurately as possible. Any Questions?

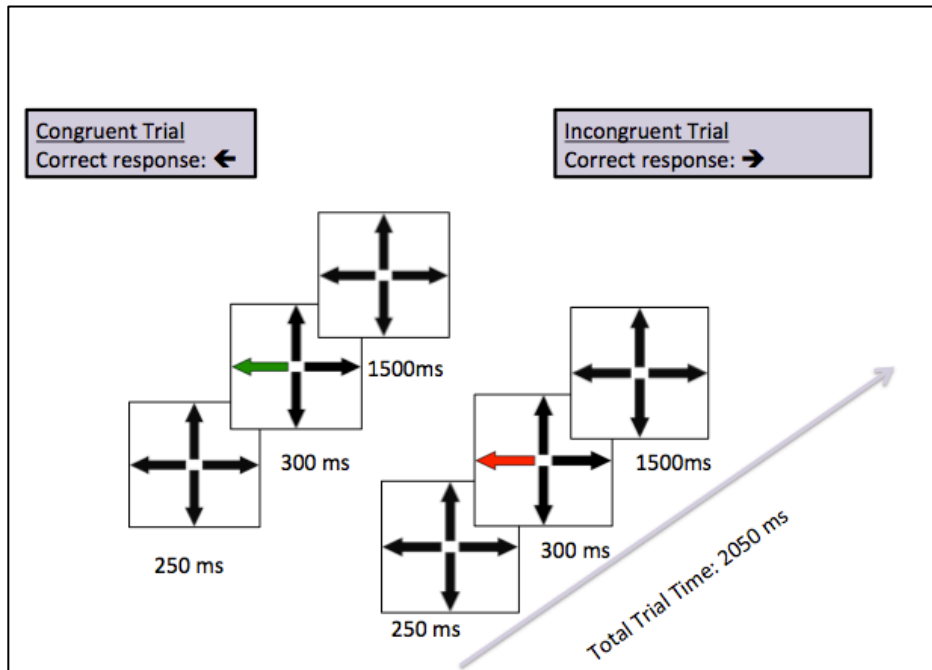

Figure 23. *Set-Shift Task*

**Updating (N-Back) (Figure 24):** This task was created as modified N-back tasks. Arrows randomly flash and participants have to keep arrows in mind. There will be a response each trial. Trials will be 0-back, 1-back, 2-back and 3-back. For example, during 1-back trials, participants will respond to trial before. *Instructions:* In this task, you will need to remember a previous arrow stimulus that was shown on the screen. Arrows will randomly flash on the screen. Keep the direction of these arrows in mind. Press the response key for the same arrow that occurred **one (two/three)** before the arrow that is currently shown on the screen. A response is required for every trial except for the first (N) trials when you are keeping track. Please respond as quickly and accurately as possible.

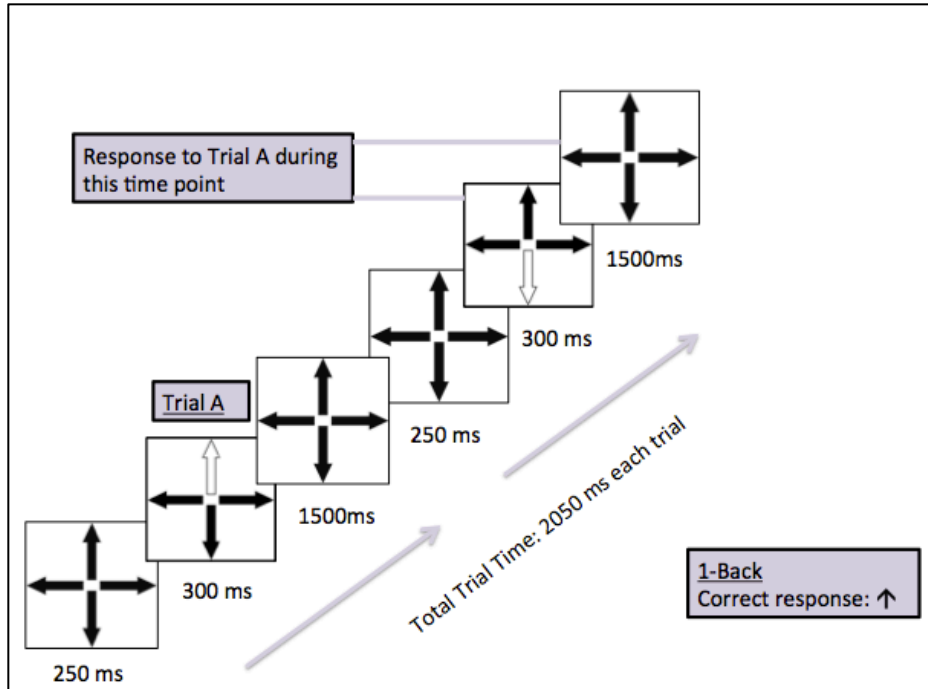

Figure 24. *N-Back Task*

### Eliminated Tasks:

**Set-Shifting (Internal) and Inhibit Task:** Participants will be shown the same stimuli as the control experiment. They will press the button that either corresponds with the direction of the stimulus, or the opposite direction (this would allow for participant to internally switch, instead of being given an external cue to switch). Every odd number trial will be a congruent trial and every even number trial will be an incongruent trial. Reaction time will be recorded.

*Instructions:* In this experiment, you will see an image of four arrows on the screen. The directions of the arrows are up, down, left and right.

When an arrow flashes, press the corresponding arrow on the number keypad for every odd trial and press the OPPOSITE arrow for every even trial.

Trials will proceed like this: same arrow, opposite arrow, same arrow, opposite arrow etc.



The 8 key is up, the 2 key is down, the 4 key is left, and the 6 key is right.

Opposite Keys: Left & Right; Up & Down

If you get lost, try to start with a congruent trial and then alternate back and forth.

Respond as quickly and accurately as possible.

Any Questions?

**Memory Buffer Task (Updating):** The set of four arrows will appear on the screen. Arrows will flicker randomly on the screen. *Version 1:* Participants are to respond to every  $n$ th instance of a flash of any arrow. For instance, if  $n=3$ , participants will have to respond every third time any arrow flashes. *Instructions:* In this task, you will need to remember previous arrows that were shown on the screen. Respond every  $N$ th (3?) time any arrow flashes. Respond as quickly and accurately as possible.

*Version 2:* This version is the same as version 1, except trials will differ regarding how many arrows need to be paid attention to.

*Memory buffer 1:* Participants respond to every  $4^{\text{th}}$  /  $n$ th instance of an arrow that has been randomly selected at the start of the experiment. Participants are only to be counting how many times that one arrow is flashed.

*Memory buffer 2:* Participants respond to every  $4^{\text{th}}$  instance of 2 arrows that have been randomly selected at the start of the experiment. They are only to be counting how many time the two arrows are flashed.

*Memory buffer 3:* Participants respond to every  $4^{\text{th}}$  instance of 3 arrows that have been randomly selected at the start of the experiment. They are only to be counting how many time the three arrows are flashed.

*Memory buffer 4:* Participants respond to every 4<sup>th</sup> instance all 4 arrows.

*Instructions:* Buffer 1: In this task, you will need to remember previous arrows that were shown on the screen. Keep track of each time you see a <<INSERT RANDOM ARROW>>. When <<RANDOM ARROW>> flashes 4 times, press the <<RANDOM ARROW>> response button. Respond as quickly and accurately as possible.

Buffer 2: In this task, you will need to remember previous arrows that were shown on the screen. Keep track of each time you see a <<INSERT RANDOM ARROW1>> and <<RANDOM ARROW 2>>. When either <<RANDOM ARROW1 >> or <<RANDOM ARROW 2>> and flashes 4 times, press the <<RANDOM ARROW>> response button. You should be keeping track of each type of arrow separately. Respond as quickly and accurately as possible.

Buffer 3: In this task, you will need to remember previous arrows that were shown on the screen. Keep track of each time you see a <<INSERT RANDOM ARROW1>>, <<RANDOM ARROW 2>>, and <<RANDOM ARROW 3>>. When <<RANDOM ARROW1 >>, <<RANDOM ARROW 2>>, or <<RANDOM ARROW 3>> and flashes 4 times, press the <<RANDOM ARROW>> response button. You should be keeping track of each type of arrow separately. Respond as quickly and accurately as possible.

Buffer 4: In this task, you will need to remember previous arrows that were shown on the screen. Respond every 4<sup>th</sup> time any arrow flashes. You should be keeping track of each type of arrow separately. Respond as quickly and accurately as possible.

**N-Back Cued Version:** Arrows randomly flash in green and participants have to keep arrows in mind. When a red arrow flashes on the screen, the participant must recall the arrow that was flashed N-back. Trials will include 0-back, 1-back, 2-back and 3-back.

### *Instructions*

*0-back:* In this experiment, you will see an image of four arrows on the screen. The directions of the arrows are up, down, left and right.

When an arrow flashes, press the corresponding arrow on the number keypad.

The 8 key is up, the 2 key is down, the 4 key is left, and the 6 key is right.

Respond as quickly and accurately as possible.

Any Questions?

*1-3 back:* In this task, you will need to remember a previous arrow stimulus that was shown on the screen. Arrows will randomly flash green. Keep the direction of these arrows in mind. When a red arrow flashes, press the response key for the same arrow that occurred **one** before the red arrow. Only respond after you see a red arrow flash. You do not need to remember the direction of the red arrow. Respond as quickly and accurately as possible.

## Appendix D

### Institutional Review Board Approval Letters



DIVISION OF RESEARCH INTEGRITY AND COMPLIANCE  
Institutional Review Boards, FWA No. 00001669  
12901 Bruce B. Downs Blvd., MDC035 • Tampa, FL 33612-4799  
(813) 974-5638 • FAX (813) 974-5618

February 5, 2013

Danielle Blinkoff, B.A.  
Psychology  
4202 E. Fowler Avenue  
Tampa, FL 33620

RE: **Expedited Approval** for Initial Review  
IRB#: Pro00009941  
Title: Examining a Set of Novel Executive Function Measures Using Event Related Potentials

Dear Ms. Blinkoff:

On 2/4/2013 the Institutional Review Board (IRB) reviewed and **APPROVED** the above referenced protocol. Please note that your approval for this study will expire on 2/4/2014.

Approved Items:

**Protocol Document:**

[Protocol](#)

**Consent Document:**

[Consent Form.pdf](#)

**Please use only the official, IRB- stamped consent document(s) found under the "Attachment Tab" in the recruitment of participants.** Please note that these documents are only valid during the approval period indicated on the stamped document.

It was the determination of the IRB that your study qualified for expedited review which includes activities that (1) present no more than minimal risk to human subjects, and (2) involve only procedures listed in one or more of the categories outlined below. The IRB may review research through the expedited review procedure authorized by 45CFR46.110 and 21 CFR

56.110. The research proposed in this study is categorized under the following expedited review categories:

(4) Collection of data through noninvasive procedures (not involving general anesthesia or sedation) routinely employed in clinical practice, excluding procedures involving x-rays or microwaves. Where medical devices are employed, they must be cleared/approved for marketing.

(6) Collection of data from voice, video, digital, or image recordings made for research purposes.

(7) Research on individual or group characteristics or behavior (including, but not limited to, research on perception, cognition, motivation, identity, language, communication, cultural beliefs or practices, and social behavior) or research employing survey, interview, oral history, focus group, program evaluation, human factors evaluation, or quality assurance methodologies.

As the principal investigator of this study, it is your responsibility to conduct this study in accordance with IRB policies and procedures and as approved by the IRB. Any changes to the approved research must be submitted to the IRB for review and approval by an amendment.

We appreciate your dedication to the ethical conduct of human subject research at the University of South Florida and your continued commitment to human research protections. If you have any questions regarding this matter, please call 813-974-5638.

Sincerely,



John A. Schinka, Ph.D., Chairperson  
USF Institutional Review Board



1/13/2014

RESEARCH INTEGRITY AND COMPLIANCE  
Institutional Review Boards, FWA No. 00001669  
12901 Bruce B. Downs Blvd., MDC035 • Tampa, FL 33612-4799  
(813) 974-5638 • FAX (813) 974-7091

Danielle Blinkoff, B.A.  
Department of Psychology  
4202 E. Fowler Avenue  
Tampa, FL 33620

RE: **Expedited Approval for Continuing Review**

IRB#: CR1\_Pro00009941

Title: Examining a Set of Novel Executive Function Measures Using Event Related Potentials

**Study Approval Period: 2/4/2014 to 2/4/2015**

Dear Ms. Blinkoff:

On 1/13/2014, the Institutional Review Board (IRB) reviewed and **APPROVED** the above application and all documents outlined below.

**Accepted Items:**

Last two executed consent forms

**Approved Item(s):**

**Protocol Document(s):**

[Protocol](#)

**Consent/Assent Document(s)\*:**

[Consent Form 5/12/13 version 2 .pdf](#)

\*Please use only the official IRB stamped informed consent/assent document(s) found under the "Attachments" tab on the main study's workspace. Please note, these consent/assent document(s) are only valid during the approval period indicated at the top of the form(s) and replace the previously approved versions.

The IRB determined that your study qualified for expedited review based on federal expedited category number(s):

(4) Collection of data through noninvasive procedures (not involving general anesthesia or sedation) routinely employed in clinical practice, excluding procedures involving x-rays or microwaves. Where medical devices are employed, they must be cleared/approved for marketing.

(6) Collection of data from voice, video, digital, or image recordings made for research purposes.

(7) Research on individual or group characteristics or behavior (including, but not limited to, research on perception, cognition, motivation, identity, language, communication, cultural beliefs or practices, and social behavior) or research employing survey, interview, oral history, focus group, program evaluation, human factors evaluation, or quality assurance methodologies.

As the principal investigator of this study, it is your responsibility to conduct this study in accordance with IRB policies and procedures and as approved by the IRB. Any changes to the approved research must be submitted to the IRB for review and approval by an amendment.

We appreciate your dedication to the ethical conduct of human subject research at the University of South Florida and your continued commitment to human research protections. If you have any questions regarding this matter, please call 813-974-5638.

Sincerely,



John Schinka, Ph.D., Chairperson  
USF Institutional Review Board